

SERVICE MANUAL

PORTABLE COMPONENT SYSTEMS

SANSUI CP-7/CP-5



NOTE:

- CP-7 and CP-5 systems are made up of following units.
 CP-7 System: CP-R7 TUNER/AMPLIFIER;
 CP-F7 CASSETTE DECK and
 CP-S7 SPEAKER SYSTEMS
 CP-5 System: CP-R5 TUNER/AMPLIFIER;
 CP-F7 CASSETTE DECK and
 CP-S5 SPEAKER SYSTEMS
- There are CP-R7 and CP-R5 respectively having the different reception bands as follows:
 - 1) FM, MW, SW₁ and SW₂ XX Model
 - 2) FM, LW, MW and SW. EU Model
- In this service manual, the differences between XX and EU Model are shown on the Parts List and Schematic Diagram as indicated below.
 - 1) (XX) XX Model only
 - 2) (EU) EU Model only



SANSUI ELECTRIC CO., LTD.

Original

• SPECIFICATIONS

• System CP-7

<XX Model Only>

Power voltage	
AC	120/220/240 V (50/60 Hz)
For U.S.A. and Canada	
	120 V (60 Hz)
Dry batteries	DC 12 V (1.5 V x 8)
Car battery	DC 12 V
Power consumption	70 watts 80 VA Rated
Dimensions	532 mm (21") W
	282 mm (11-1/8") H
	193 mm (7-5/8") D
Weight	9.8 kg (21.6 lbs.) net
	12.7 kg (28.0 lbs.) packed

<EU Model Only>

Power Voltage	
AC	220/240 V (50 Hz)
Dry batteries	DC 12 V (1.5 V x 8)
Car battery	DC 12 V
Power consumption	95 watts Maximum
Dimensions	532 mm (21") W
	282 mm (11-1/8") H
	193 mm (7-5/8") D
Weight	9.8 kg (21.6 lbs.) net

Tuner/amplifier: CP-R7

Audio section <XX, EU Model>

Power output

Min. RMS, both channels driven, from 70 to 15,000 Hz with no more than 5% total harmonic distortion

13 watts per channel into 4 ohms

Total harmonic distortion

less than 5% at or below rated min.

RMS power output

Frequency response (at 1 watt)

30 to 30,000 Hz, +3 dB, -3 dB

Input sensitivity and impedance (at 1 kHz)

PHONO 2.5 mV/47 kilohms

AUX, TAPE PLAY 75 mV/47 kilohms

Signal to noise ratio (short-circuit, A-network)

PHONO 72 dB

AUX, TAPE PLAY 75 dB

FM section <XX EU Model>

Tuning range 87.5 to 108 MHz

Usable sensitivity

Mono 14 dBf

50 dB quieting sensitivity

Stereo 40 dBf

Signal to noise ratio (at 65 dBf)

Stereo 68 dB

Distortion (at 65 dBf)

Stereo less than 0.5% at 1,000 Hz

Stereo separation 35 dB at 1,000 Hz

AM section

<XX Model Only>

Tuning range

MW 530 to 1,620 kHz (10 kHz)

522 to 1,611 kHz (9 kHz)

SW1 3.8 to 12 MHz

SW2 5.8 to 15.5 MHz

Usable sensitivity

MW 50 dB/m

SW1, SW2 14 dB/μV

Signal to noise ratio 45 dB

<EU Model Only>

Tuning range

MW 522 to 1,611 kHz

LW 155 to 281 kHz

SW 5.8 to 15.5 MHz

Usable sensitivity

MW 50 dB/m

LW 60 dB/m

SW 14 dB/μV

Signal to noise ratio 45 dB

<XX, EU Model>

Dimensions 270 mm (10-11/16") W

106 mm (4-3/16") H

193 mm (7-5/8") D

Weight 3.1 kg (6.8 lbs.) net

to be continued ▶

3. ADJUSTMENTS

3-1. Reference Frequency Adjustment of Synthesizer Control Circuit <CP-R7>

- Note: 1. Selector Switch TUNER
 2. Band Selector Switch MW
 3. See Fig. 3-7 on page 6 for MEASURE OUTPUT point.

STEP	SETTING	MEASURE OUTPUT	ADJUST	ADJUST FOR	REMARKS
1.	Memorize 1450 kHz using Memory key 1	Point (E) (Pin 91 of F-3693) Frequency Counter	TTC1 (F-3688)	1450.0 kHz	

3-2. FM Adjustment <CP-R7>

Fig. 3-1

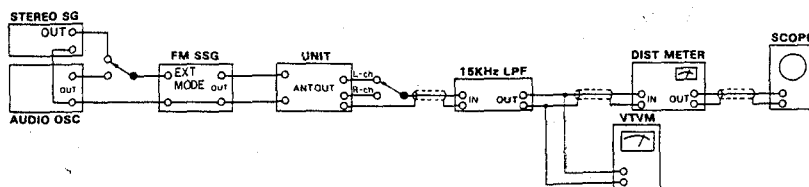

(1) FM IF Adjustment

- Note: 1. Selector Switch TUNER
 2. Band Selector Switch FM
 3. FM MODE Switch MONO
 4. See Fig. 3-5 on page 6 for MEASURE OUTPUT and ADJUST point.

STEP	SUBJECT	FEED SIGNAL		MEASURE OUTPUT	ADJUST	ADJUST FOR	REMARKS
		FROM	TO				
1.	Discriminator coil adj.	98MHz ANT Input 65.2dBf (60dB) (No.MOD.)	ANT terminal 75Ω	Between TP1 and TP2 of F-3644 DC Volt Meter	dT1 (F-3644)	+5mV ~ -5mV	

◆ FM RF adjustment & Dial Calibration are not necessary. When these circuits are defective, replace FM Front-end Pack with new one.

(2) FM Stereo Adjustment

- Note: 1. Selector Switch TUNER
 2. Band Selector Switch FM
 3. FM MODE Switch STEREO
 4. See Figs. 3-5, 3-7 on page 6 for MEASURE OUTPUT and ADJUST point.

STEP	SUBJECT	FEED SIGNAL		MEASURE OUTPUT	ADJUST	ADJUST FOR	REMARKS
		FROM	TO				
1.	PLL VCO Adj.	98MHz ANT Input 65dBf (59.8dB), FM SSG, Pilot 19kHz (9% MOD.), R or L MODE 1kHz + Pilot (100% MOD.), STEREO SG	ANT terminal 75Ω	Stereo Indicator	dVR1 (F-3644)	Light indicator	Adjust the dVR1 within center of lighting level
	PLL VCO Adj. In case of using Freq. Counter	No Input	—	Pin 9 of dIC2 Freq. Counter (F-3644)	dVR1 (F-3644)	19kHz ± 200Hz	
2.	Muting Level Adj.	98MHz ANT Input 18dBf (12.8dB), 1kHz (100% MOD.), FM SSG	ANT terminal 75Ω	Tuner Out or Indicator VTVM, Scope	dVR2 (F-3693)	Output signal comes out.	

8-3. Tuner Section <CP-R7 EU Model>

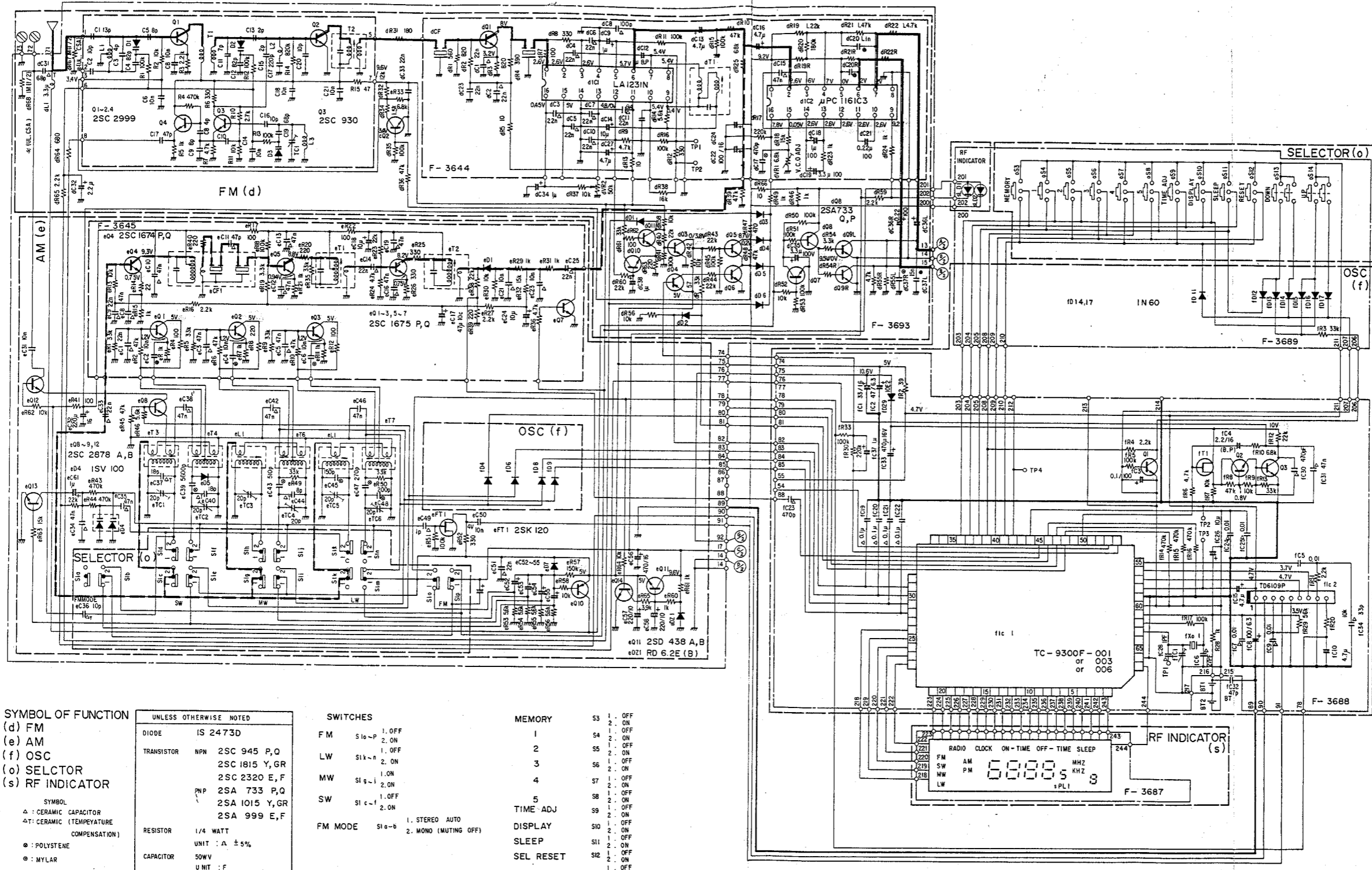

SYMBOL OF FUNCTION
 (d) FM
 (e) AM
 (f) OSC
 (o) SELECTOR
 (s) RF INDICATOR

UNLESS OTHERWISE NOTED

DIODE	IS 2473D
TRANSISTOR	NPN 2SC 945 P,Q 2SC 1815 Y,GR 2SC 2320 E,F PNP 2SA 733 P,Q 2SA 1015 Y,GR 2SA 999 E,F
RESISTOR	1/4 WATT UNIT : Ω $\pm 5\%$
CAPACITOR	50WV UNIT : F

SWITCHES
 FM S1a-P 1.OFF
 2.ON
 LW S1k-a 2.ON
 MW S1e-l 1.ON
 2.ON
 SW S1c-1 1.OFF
 2.ON
 FM MODE S1e-b 1. STEREO AUTO
 2. MONO (MUTING OFF)

MEMORY
 53 1. OFF
 2. ON
 54 1. OFF
 2. ON
 55 1. OFF
 2. ON
 56 2. ON
 57 1. OFF
 2. ON
 58 ON
 59 1. OFF
 2. ON
 60 1. OFF
 2. ON
 61 1. OFF
 2. ON
 62 1. OFF
 2. ON
 63 1. OFF
 2. ON
 64 1. OFF
 2. ON
 65 1. OFF
 2. ON
 66 1. OFF
 2. ON
 67 1. OFF
 2. ON
 68 1. OFF
 2. ON
 69 1. OFF
 2. ON
 70 1. OFF
 2. ON
 71 1. OFF
 2. ON
 72 1. OFF
 2. ON
 73 1. OFF
 2. ON
 74 1. OFF
 2. ON
 75 1. OFF
 2. ON
 76 1. OFF
 2. ON
 77 1. OFF
 2. ON
 78 1. OFF
 2. ON
 79 1. OFF
 2. ON
 80 1. OFF
 2. ON
 81 1. OFF
 2. ON
 82 1. OFF
 2. ON
 83 1. OFF
 2. ON
 84 1. OFF
 2. ON
 85 1. OFF
 2. ON
 86 1. OFF
 2. ON
 87 1. OFF
 2. ON
 88 1. OFF
 2. ON
 89 1. OFF
 2. ON
 90 1. OFF
 2. ON
 91 1. OFF
 2. ON
 92 1. OFF
 2. ON
 93 1. OFF
 2. ON
 94 1. OFF
 2. ON
 95 1. OFF
 2. ON
 96 1. OFF
 2. ON
 97 1. OFF
 2. ON
 98 1. OFF
 2. ON
 99 1. OFF
 2. ON
 100 1. OFF
 2. ON

- 2SA733
- 2SA999
- 2SA1015
- 2SB865
- 2SC945
- 2SC1674
- 2SC1675
- 2SC1815
- 2SC1845
- 2SC2320
- 2SC2878
- 2SD438
- 2SK120
- 2SK163
- 2SB507
- TD6109P
- #PC1230H
- LA1231
- TC40018P
- UPC1161C
- BA328
- DAN601
- DAN201
- DAP201
- 10E2
- 30D2
- 1N60
- 1S1588
- 1S2473D
- RD6.2E
- RD10E
- RD12F
- TC9300F-001

— FM Signal Line
 - - - AM Signal Line

1
 2
 3
 4
 5

3-3. FM Adjustment <CP-R5>

- Note: 1. Selector Switch TUNER
 2. Band Selector Switch FM
 3. See Figs. 3-5, 3-8 on page 6 for MEASURE OUTPUT and ADJUST point.

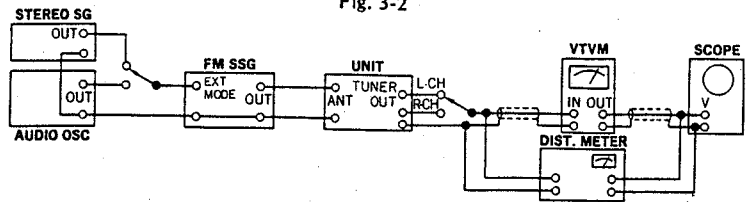

(1) FM IF, RF Adjustment and Dial Calibration

- Note: 1. FM MODE Switch MONO

STEP	SUBJECT	FEED SIGNAL		MEASURE OUTPUT	ADJUST	ADJUST FOR	REMARKS
		FROM	TO				
1.	Discriminator coil adj.	98MHz ANT Input 65dBf (59.8dB), 1kHz (100% MOD.), FM SSG	ANT terminal 75Ω	Between both lead wires of dR12 (TP1 and TP2), F-3644 DC Volt Meter	dT1 (F-3644)	-5mV ~ +5mV	
2.	90MHz Dial Calibration	90MHz ANT Input 65dBf (59.8dB), 1kHz (100% MOD.), FM SSG	Same as above	Dial Pointer LED	TUNING Knob	90MHz	
				TUNER OUTPUT L-ch (Connector Pin No. 13, F-3646) or R-ch (Connector Pin No. 15, F-3646) VTVM & Scope	dL4 (F-3646)	MAX. Output	Turning point of the dial pointer LED from red to green.
3.	106MHz Dial Calibration	106MHz ANT Input 65dBf (59.8dB), 1kHz (100% MOD.), FM SSG	Same as above	Dial Pointer LED	TUNING Knob	106MHz	
				TUNER OUTPUT L-ch (Connector Pin No. 13, F-3646) or R-ch (Connector Pin No. 15, F-3646) VTVM & Scope	dTC3 (F-3646)	MAX. Output	Turning point of the dial pointer LED from red to green.
4.	90MHz RF Adj.	90MHz ANT Input Minimum Value with sine wave 1kHz (100% MOD.), FM SSG	Same as above	TUNER OUTPUT L-ch (Connector Pin No. 13, F-3646) or R-ch (Connector Pin No. 15, F-3646) VTVM & Scope	dL2, dL3, (F-3646)	Same as above	
5.	106MHz RF Adj.	106MHz ANT Input Minimum Value with sine wave 1kHz (100% MOD.), FM SSG	Same as above	Same as above	dTC1, dTC2, (F-3646)	Same as above	

(2) FM STEREO Adjustment

- Note: 1. FM MODE Switch STEREO

STEP	SUBJECT	FEED SIGNAL		MEASURE OUTPUT	ADJUST	ADJUST FOR	REMARKS
		FROM	TO				
1.	PLL VCO Adj.	98MHz ANT Input 65dBf (59.8dB) FM SSG Pilot 19kHz (9% MOD.) SUB 1kHz + Pilot (100% MOD.) STEREO SG	ANT terminal 75Ω	Stereo indicator	dVR1 (F-3644)	Light indicator	Adjust the dVR1 within center of lighting level.
	PLL VCO Adj. In case of using Freq. counter	No Input	—	Pin No. 9 of dIC2 (F-3644) Freq. counter	dVR1 (F-3644)	19kHz ± 200Hz	
2.	IF Coil (dT3) Adj.	98MHz ANT Input 65dBf (59.8dB) FM SSG Pilot 19kHz (9% MOD.) L MODE 1kHz + Pilot (100% MOD.) STEREO SG	ANT terminal 75Ω	TUNER OUTPUT L-ch (Connector Pin No. 13, F-3646), Dist. Meter	dT3 (F-3646)	Min. THD	

◆ Selection of Intermediate Frequency (FM) <CP-R5>

When the frequency (separated by color) of the ceramic filter is changed, unity the color marks of the FM ceramic filters (dCF1 and dCF2) on the F-3646.

3-4. AM IF Adjustment <CP-R7/CP-R5>

- Note: 1. Selector Switch TUNER
 2. Band Selector Switch MW
 3. When F-3645 AM IF circuit board is out of adjustment, replace it with new board.
 4. See Fig. 3-6 on page 6 for FEED SIGNAL, MEASURE OUTPUT and ADJUST point.

Fig. 3-3

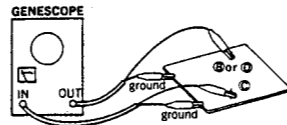

STEP	SUBJECT	FEED SIGNAL		MEASURE OUTPUT	ADJUST	ADJUST FOR	REMARKS
		FROM	TO				
1.	IF Coil Adj.	Genescope Output 90dB	Point B through 0.022μF connect 0.047μF between A point and ground (F-3645)	Point C (F-3645)	eT2 (F-3645)	MAX. Output	
2.		Genescope Output 50dB	Point D through 0.022μF and 1kΩ (F-3645)	Point C (F-3645)	eCF1 (F-3645)	MAX. Output	

Fig. 3-4

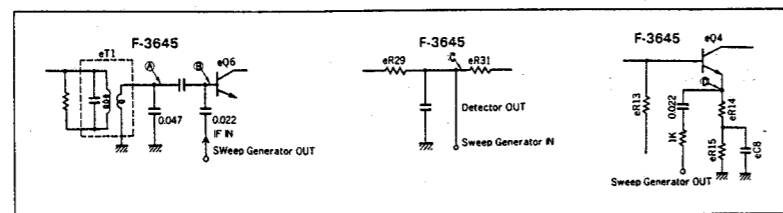

3-5. AM RF and Dial Calibration <CP-R7>

- Note: 1. Selector Switch TUNER
 2. Band Selector Switch MW, SW1, SW2, LW
 3. See Fig. 3-7 on page 6 for MEASURE OUTPUT and ADJUST point.
 4. Preset the following frequencies to the memories.

MEMORY KEY	MW	SW1	SW2(SW)	LW
SW2				
1 (6)	522kHz	3.8MHz	5.8MHz	155kHz
2 (7)	603kHz	4.4MHz	6.6MHz	164kHz
4 (9)	1404kHz	10.0MHz	14.0MHz	272kHz
5 (10)	1611kHz	12.0MHz	15.5MHz	281 kHz

(1) XX Model (FM, MW, SW1 and SW2)

a) Dial Calibration

STEP	SUBJECT	SETTING	MEASURE OUTPUT	ADJUST	ADJUST FOR	REMARKS
1.	MW Dial Calibration	Depress MEMORY key 1 to readout 522kHz	Point F (between eR42 and Ground of F-3693 DC Volt Meter)	eT7 (F-3693)	0.9V ± 0.1V	
		Depress MEMORY key 5 to readout 1611kHz	Same as above	eTC6 (F-3693)	8.4V ± 0.1V	
2.	SW1 Dial Calibration	Depress MEMORY key 1 to readout 3.8MHz	Same as above	eT6 (F-3693)	0.9V ± 0.1V	
		Depress MEMORY key 5 to readout 12MHz	Same as above	eTC4 (F-3693)	8.4V ± 0.1V	
3.	SW2 Dial Calibration	Depress MEMORY key 6 to readout 5.8MHz	Same as above	eT4 (F-3693)	0.9V ± 0.1V	
		Depress MEMORY key 10 to readout 15.5kHz	Same as above	eTC2 (F-3693)	8.4V ± 0.1V	

ADJUSTMENT FOR FM

- The impedance of FM antenna terminal is 75Ω. Therefore, connect coaxial cable (3C-2V etc.) between FM SG and antenna terminal when wiring.
- There are two kind in indication of FM SG output attenuator.
 - Attenuator with marking of 75Ω open . . . open indication type.
 - Attenuator with marking of 75Ω load or close . . . load or close indication type.
- FM SG output level in this FM adjustment are described as open indication type. The right table shows relations among FM SG attenuator indication (dB), available power ratio (dBf) and antenna terminal voltage (dB/μV) in each indication type, close indication type.

	FM SG Attenuator Indication	Available Power Ratio	Antenna Terminal Voltage
Open indication type	0 dB 60 dB	5.2 dBf 65.2 dBf	6 dB/μV 66 dB/μV
Load or close indication type	0 dB 54 dB	11.2 dBf 65.2 dBf	12 dB/μV 66 dB/μV

Fig. 3-5 <CP-R7/CP-R5>

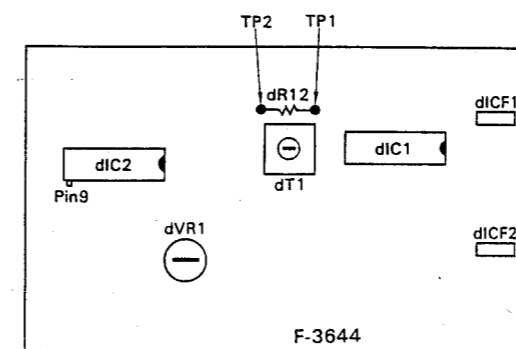

Fig. 3-6 <CP-R7/CP-R5>

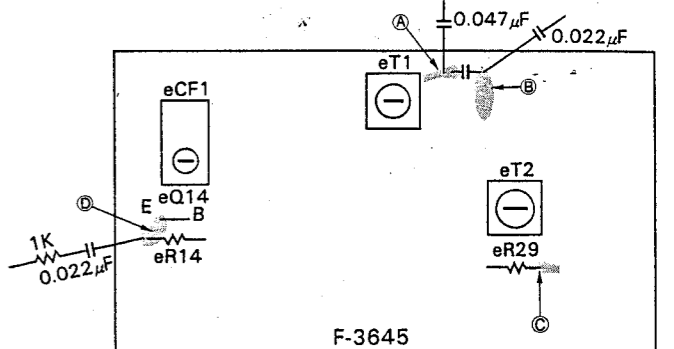

Fig. 3-7 <CP-R7>

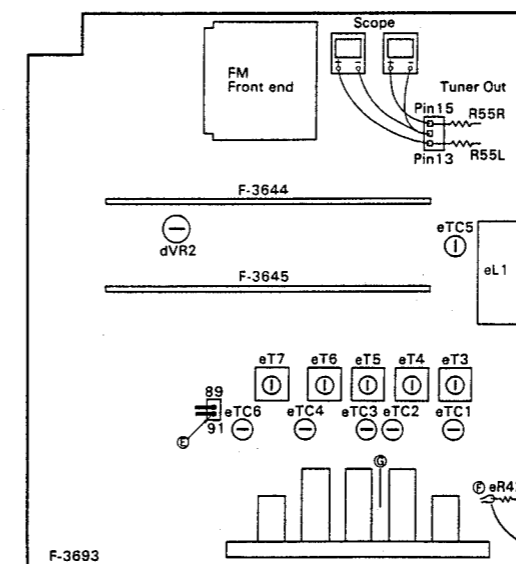
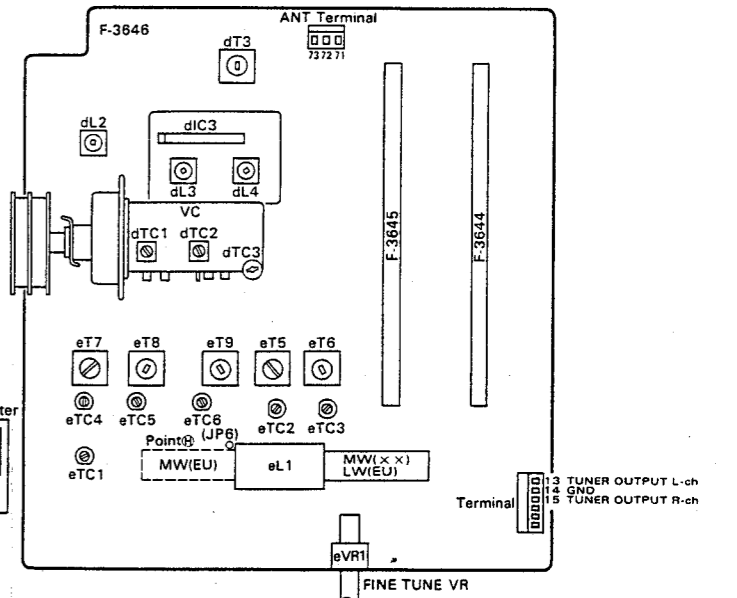
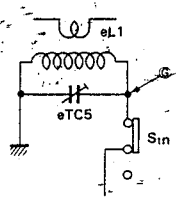

Fig. 3-8 <CP-R5>



b) RF Adjustment

STEP	SUBJECT	FEED SIGNAL		MEASURE OUTPUT	ADJUST	ADJUST FOR	REMARKS
		FROM	TO				
1.	MW 603kHz RF Adj.	603kHz 34dB 400Hz (30% MOD.) AM SSG	Point ③ (F-3693)	TUNER OUTPUT Connector Pin L-CH No. 13, R-CH No. 15 VTVM, SCOPE (F-3693)	Bar Antenna (L1) (F-3693)	MAX. Output	
	MW 1404kHz RF Adj.	1404kHz 34dB 400Hz (30% MOD.) AM SSG	Same as above	Same as above	eTC5 (F-3693)	Same as above	
2.	SW1 4.4MHz RF Adj.	4.4MHz 20dB 400 Hz (30% MOD.) AM SSG	ANT terminal 75Ω	Same as above	eT5 (F-3693)	Same as above	
	SW1 10MHz RF Adj.	10MHz 20dB 400Hz (30% MOD.) AM SSG	Same as above	Same as above	eTC1 (F-3693)	Same as above	
3.	SW2 6.6MHz RF Adj.	6.6MHz 20dB 400Hz (30% MOD.) AM SSG	Same as above	Same as above	eT3 (F-3693)	Same as above	
	SW2 14MHz RF Adj.	14MHz 20dB 400Hz (30% MOD.) AM SSG	Same as above	Same as above	eTC1 (F-3693)	Same as above	

(2) EU Model (FM, MW, SW and LW)

a) Dial Calibration

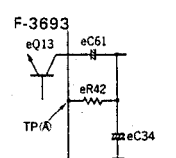
STEP	SUBJECT	SETTING	MEASURE OUTPUT	ADJUST	ADJUST FOR	REMARKS
1.	LW Dial Calibration	Depress MEMORY key 1 to readout 155kHz	Point ① (between eR42 and ground of F-3693) DC Volt Meter	eT7 (F-3693)	0.9V ± 0.1V	
		Depress MEMORY key 2 to readout 164kHz	Same as above	eTC6 (F-3693)	8.4V ± 0.1V	
2.	MW Dial Calibration	Depress MEMORY key 1 to readout 1522kHz	Same as above	eT6 (F-3693)	0.9V ± 0.1V	
		Depress MEMORY key 5 to readout 1611kHz	Same as above	eTC4 (F-3693)	8.4V ± 0.1V	
3.	SW Dial Calibration	Depress MEMORY key 1 to readout 5.8MHz	Same as above	eT4 (F-3693)	0.9V ± 0.1V	
		Depress MEMORY key 5 to readout 15.5kHz	Same as above	eTC2 (F-3693)	8.4V ± 0.1V	

b) RF Adjustment

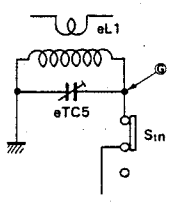
STEP	SUBJECT	FEED SIGNAL		MEASURE OUTPUT	ADJUST	ADJUST FOR	REMARKS
		FROM	TO				
1.	LW 164kHz RF Adj.	164kHz 45dB 400Hz (30% MOD.) AM SSG	Point ③ (F-3693)	TUNER OUTPUT Connector Pin L-CH No. 13, R-CH No. 15 VTVM, SCOPE (F-3693)	Bar Antenna (L1) (F-3693)	MAX. Output	
	LW 272kHz RF Adj.	272kHz 45dB 400Hz (30% MOD.) AM SSG	Same as above	Same as above	eTC5 (F-3693)	Same as above	
2.	MW 603kHz RF Adj.	603kHz 35dB 400Hz (30% MOD.) AM SSG	Same as above	Same as above	Bar Antenna (L1) (F-3693)	Same as above	
	MW 1404kHz RF Adj.	1404kHz 35dB 400Hz (30% MOD.) AM SSG	Same as above	Same as above	eTC3 (F-3693)	Same as above	
3.	SW 6.6MHz RF Adj.	6.6MHz 20dB 400Hz (30% MOD.) AM SSG	ANT terminal 75Ω	Same as above	eT3 (F-3693)	Same as above	
	SW 14MHz RF Adj.	14MHz 20dB 400Hz (30% MOD.) AM SSG	Same as above	Same as above	eTC1 (F-3693)	Same as above	

3-6. AM RF Adjustment and Dial Calibration <CP-R5>

- Note: 1. Selector Switch TUNER
 2. Fine Tune Volume (eVR1) Center Position
 3. See Fig. 3-8 on page 6 for MEASURE OUTPUT and ADJUST point.

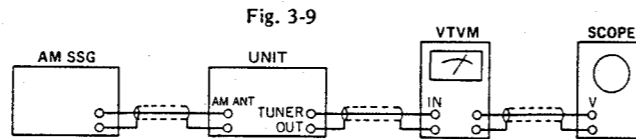

(1) XX Model (FM, MW, SW1 and SW2)

STEP	BAND SELECTOR SWITCH	SUBJECT	FEED SIGNAL		MEASURE OUTPUT	ADJUST	ADJUST FOR	REMARKS
			FROM	TO				
1.	MW	600kHz Dial Calibration	600kHz Input 60dB 400kHz (MOD. 30%), AM SSG	Point (H) (JP6, F-3646)	TUNER OUTPUT L-ch (Connector Pin No. 13, F-3646) or R-ch (Connector Pin No. 15, F-3646) VTVM & Scope	eT7 (F-3646)	MAX. Output	Turning point of the dial pointer LED from red to green.
		1400kHz Dial Calibration	1400kHz Input 60dB 400kHz (MOD. 30%), AM SSG	Same as above	Same as above	eTC4 (F-3646)	Same as above	
2.	SW1	2.5MHz Dial Calibration	2.5MHz ANT Input 60dB 400kHz (MOD. 30%), AM SSG	ANT terminal 75Ω	Same as above	eT8 (F-3646)	Same as above	Same as above
		6MHz Dial Calibration	6MHz ANT Input 60dB 400kHz (MOD. 30%), AM SSG	Same as above	Same as above	eTC6 (F-3646)	Same as above	
3.	SW2	8MHz Dial Calibration	8MHz ANT Input 60dB 400kHz (MOD. 30%), AM SSG	Same as above	Same as above	eT9 (F-3646)	Same as above	Same as above
		18MHz Dial Calibration	18MHz ANT Input 60dB 400kHz (MOD. 30%), AM SSG	Same as above	Same as above	eTC6 (F-3646)	Same as above	
4.	MW	600kHz RF Adj.	600kHz Input 60dB 400kHz (MOD. 30%), AM SSG	Point (H) (JP6, F-3646)	Same as above	eL1 (F-3646)	Same as above	
		1400kHz RF Adj.	1400kHz Input 60dB 400kHz (MOD. 30%), AM SSG	Same as above	Same as above	eTC1 (F-3646)	Same as above	
5.	SW1	2.5MHz RF Adj.	2.5MHz ANT Input 60dB 400kHz (MOD. 30%), AM SSG	ANT terminal 75Ω	Same as above	eT5 (F-3646)	Same as above	
		6MHz RF Adj.	6MHz ANT Input 60dB 400kHz (MOD. 30%), AM SSG	Same as above	Same as above	eTC2 (F-3646)	Same as above	
6.	SW2	8MHz RF Adj.	8MHz ANT Input 60dB 400kHz (MOD. 30%), AM SSG	Same as above	Same as above	eT6 (F-3646)	Same as above	
		18MHz RF Adj.	18MHz ANT Input 60dB 400kHz (MOD. 30%), AM SSG	Same as above	Same as above	eTC3 (F-3646)	Same as above	

(2) EU Model (FM, LW, MW and SW)

STEP	BAND SELECTOR SWITCH	SUBJECT	FEED SIGNAL		MEASURE OUTPUT	ADJUST	ADJUST FOR	REMARKS
			FROM	TO				
1.	LW	170kHz Dial Calibration	170kHz Input 60dB 400kHz (MOD. 30%), AM SSG	Point (H) (JP6, F-3646)	TUNER OUTPUT L-ch (Connector Pin No. 13, F-3646) or R-ch (Connector Pin No. 15, F-3646) VTVM & Scope	eT7 (F-3646)	MAX. Output	Turning point of the dial pointer LED from red to green.
		300kHz Dial Calibration	300kHz Input 60dB 400kHz (MOD. 30%), AM SSG	Same as above	Same as above	eTC4 (F-3646)	Same as above	
2.	MW	600kHz Dial Calibration	600kHz Input 60dB 400kHz (MOD. 30%), AM SSG	Same as above	Same as above	eT8 (F-3646)	Same as above	Same as above
		1400kHz Dial Calibration	1400kHz Input 60dB 400kHz (MOD. 30%), AM SSG	Same as above	Same as above	eTC5 (F-3646)	Same as above	
3.	SW	8MHz Dial Calibration	8MHz ANT Input 60dB 400kHz (MOD. 30%), AM SSG	ANT terminal 75Ω	Same as above	eT9 (F-3646)	Same as above	Same as above
		18MHz Dial Calibration	18MHz ANT Input 60dB 400kHz (MOD. 30%), AM SSG	Same as above	Same as above	eTC6 (F-3646)	Same as above	
4.	LW	170kHz RF Adj.	170kHz Input 60dB 400kHz (MOD. 30%), AM SSG	Point (H) (JP6, F-3646)	Same as above	eL1 (LW) (F-3646)	Same as above	
		300kHz RF Adj.	300kHz Input 60dB 400kHz (MOD. 30%), AM SSG	Same as above	Same as above	eTC1 (F-3646)	Same as above	
5.	MW	600kHz RF Adj.	600kHz Input 60dB 400kHz (MOD. 30%), AM SSG	Same as above	Same as above	eL1 (MW) (F-3646)	Same as above	
		1400kHz RF Adj.	1400kHz Input 60dB 400kHz (MOD. 30%), AM SSG	Same as above	Same as above	eTC2 (F-3646)	Same as above	
6.	SW	8MHz RF Adj.	8MHz ANT Input 60dB 400kHz (MOD. 30%), AM SSG	ANT terminal 75Ω	Same as above	eT6 (F-3646)	Same as above	
		18MHz RF Adj.	18MHz ANT Input 60dB 400kHz (MOD. 30%), AM SSG	Same as above	Same as above	eTC3 (F-3646)	Same as above	

•Abbreviations-

Equipment	Others
AM FM Generator Oscilloscope Genescope	Antenna ANT.
AM Standard Signal Generator AM SSG	Modulation MOD.
FM Standard Signal Generator FM SSG	Total Harmonic Distortion T.H.D.
FM Stereo Generator Stereo SG	
Oscilloscope Scope	
Audio Oscillator Audio Osc.	
Distortion Meter Dist. Meter	

5. OTHER PARTS

5-1. Front View <CP-R7/CP-S7>

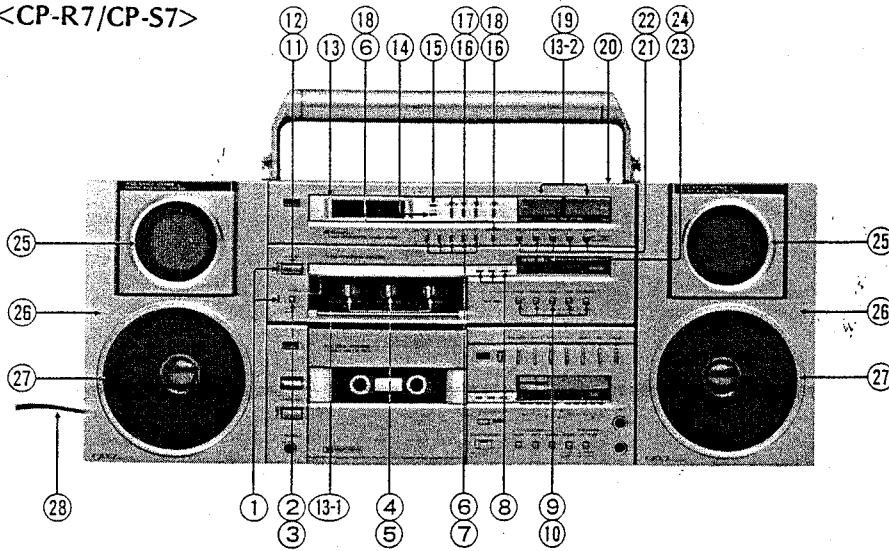

5-2. Rear View <CP-R7/CP-S7>

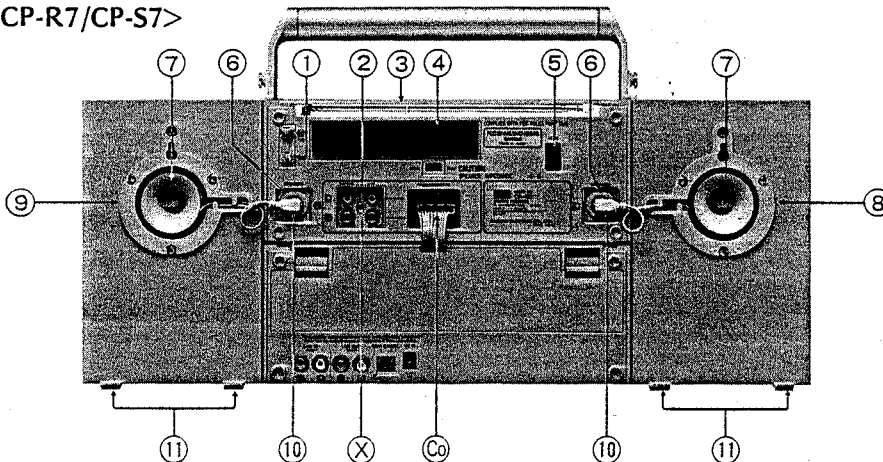

Parts List <Front View>

Parts No.	Stock No.	Description
1	46095200	LED, TIMER/POWER Indicator
2	46182600	Push SW., TIMER
3	07851000	Knob, TIMER SW.
4	46189100	BALANCE/TONE VR, 100k Ω x 2, 250k Ω
5	07852200	Knob, BALANCE/TONE VR
6	46184600	Push SW., 1 ~ 5 (MEMORY)/MEMORY
7	07850600	Knob, 1 ~ 5 (MEMORY)
8	46095200	LED, PHONO/TAPE/TUNER
9	46182800	Push SW., SELECTOR/TAPE/LOUDNESS
10	07851000	Knob, SELECTOR/TAPE/LOUDNESS SW.
11	07261300	Push SW., POWER
12	07850900	Knob, POWER SW.
13	07856900	Front Panel Ass'y (XX)
	07868700	Front Panel Ass'y (EU)
13-1	07848700	Tone Volume Cover
13-2	07850800	UP, DOWN SW. Knob
14	46095200	LED, STEREO Indicator
15	07250900	LED, LOCKED Indicator
16	46184600	Push SW., DISPLAY/TIME ADJ./SEC RESET/SLEEP
17	07850600	Knob, DISPLAY/TIME ADJ./SEC RESET SW.
18	07850700	Knob, SLEEP SW.
19	07224100	Push SW., UP/DOWN
20	07845800	Bonnet

Parts No.	Stock No.	Description
21	46182700	Push SW., FM/MW/SW1/SW2 (LW)/FM MODE SW
22	07851100	Knob, FM/MW/SW1/SW2 (LW)/FM MODE SW.
23	46188800	Slide VR 150k Ω B x 2, master VR
24	07852000	Knob, master VR
25	46203800	Passive Radiator, P-111
26	07872900	Front Baffle Cover (A) Ass'y
27	46203700	FS-114, Fullrange Speaker
28	46186300	Power Supply Cord (XX)
	46186400	Power Supply Cord (EU)

Parts List <Rear View>

Parts No.	Stock No.	Description
1	46200000	Terminal, FM 75 Ω /GND
2	46200100	4P Input Terminal
3	46199400	Rod Antenna
4	07861900	Battery Case Cover
5	46182300	AC Inlet (XX)
	46182400	AC Inlet (EU)
6	46200200	DIN Jack, SPEAKER Connector
7	07849600	Sub Speaker Cord Reel
8	07849700	Speaker Cord Reel (L-ch)
9	07849900	Speaker Cord Reel (R-ch)
10	46203100	2P DIN Speaker Cord
11	07853700	Leg

5-3. Top View <CP-R7>

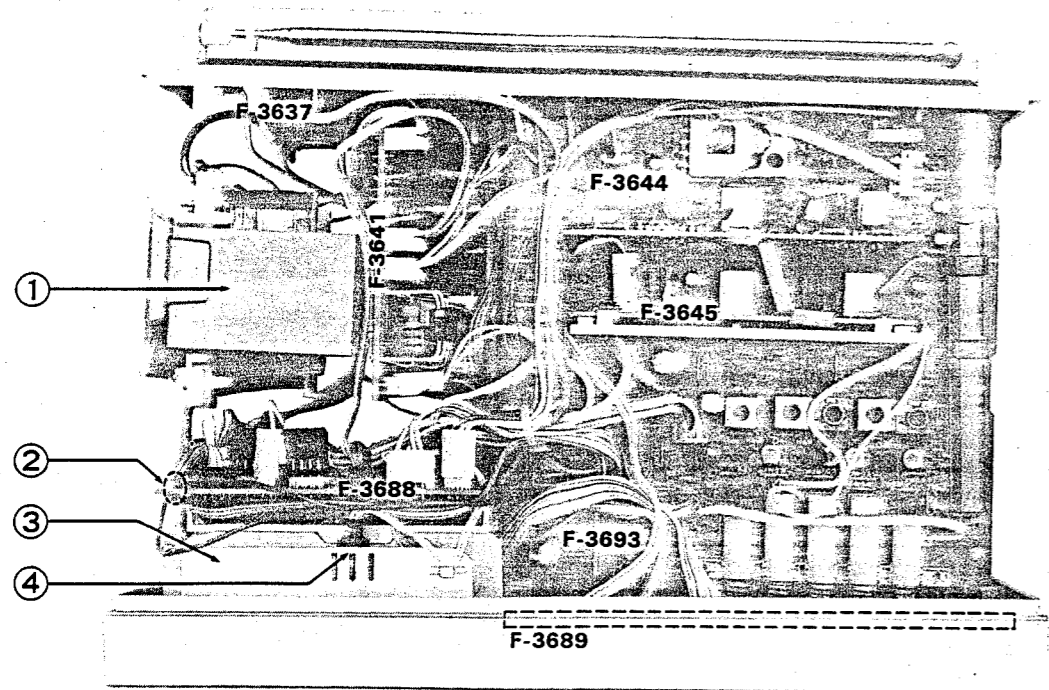

5-4. Bottom View <CP-R7>

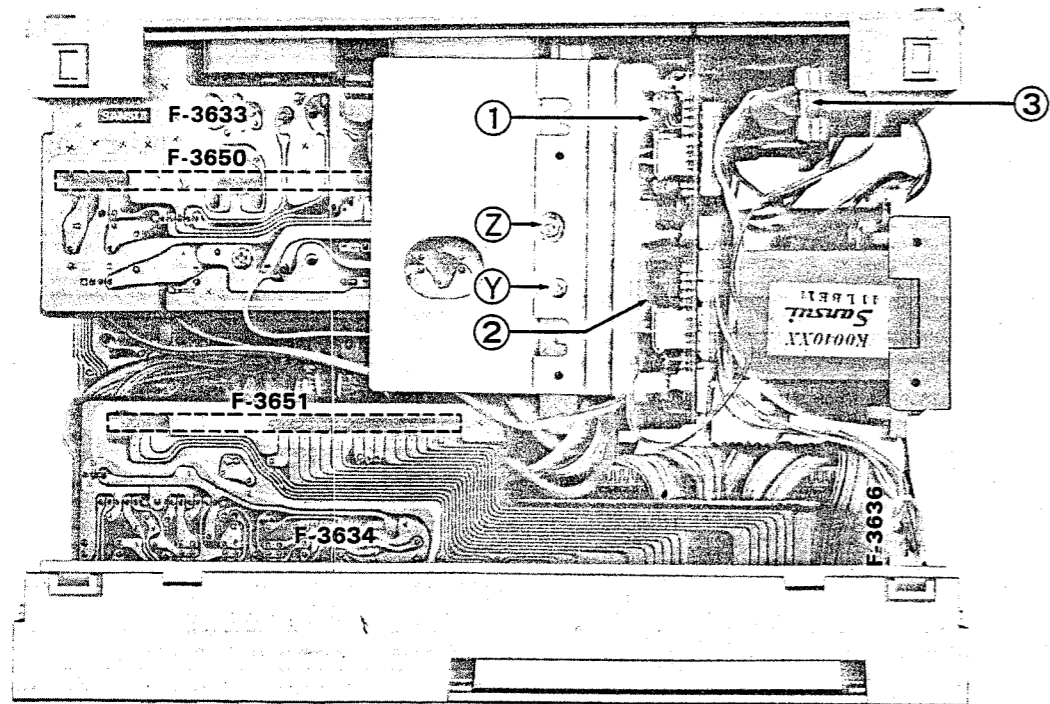

Parts List <Top View>

Parts No.	Stock No.	Description
1	15006601	Power Transformer (XX)
	15006605	Power Transformer (EU)
3	07858900	Illumination Case
4	46208200	Pilot Lamp, 12 V 150 mA

Parts List <Bottom View>

Parts No.	Stock No.	Description
1	46183600	Power Amp IC (L-ch), K1C1 μ PC1230H
2	46183600	Power Amp IC (R-ch), K1C1 μ PC1230H
3	46201500	AC Fuse 1A 250 V (AC 120 V) (XX)
	46201200	AC Fuse 0.5A 250 V (AC 220 V) (XX)
	07184200	AC Fuse 0.315A 250 V (EU)

5-5. Front View <CP-R5/CP-S5>

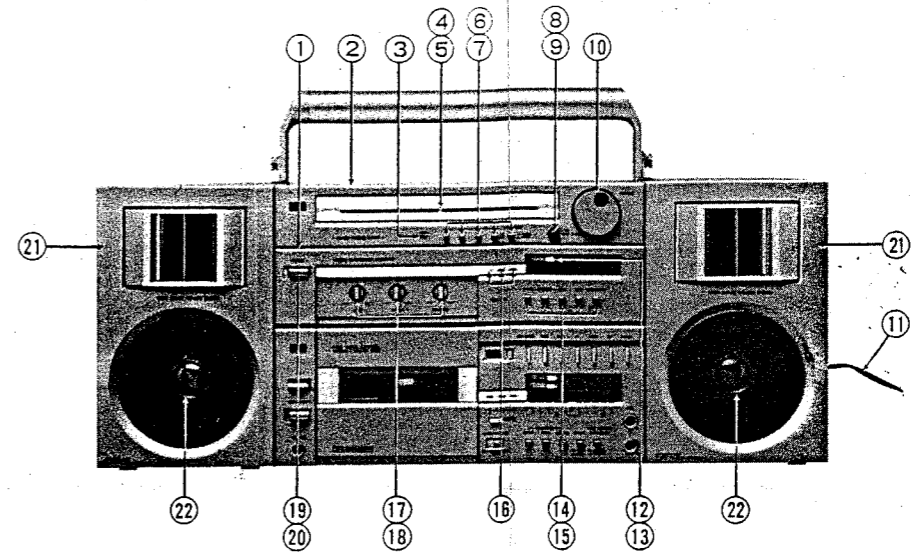

5-6. Rear View <CP-R5/CP-S5>

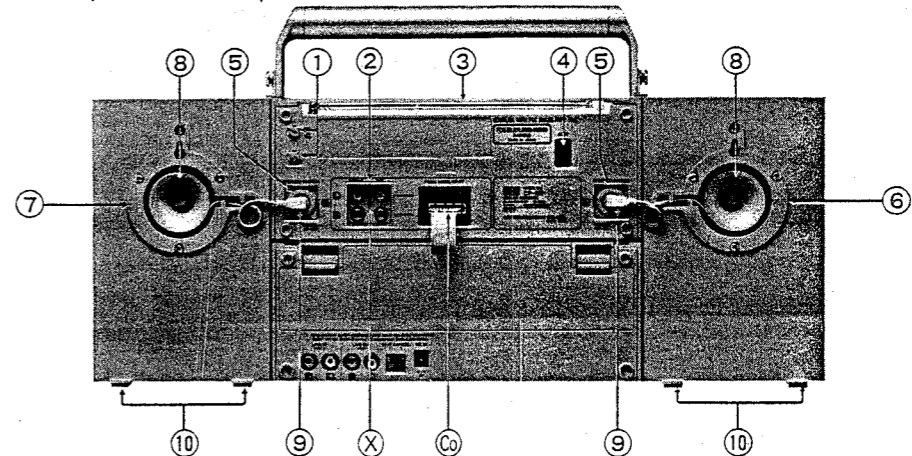

Parts List <Front View>

Parts No.	Stock No.	Description
1	07858500	Front Panel Ass'y (XX)
	07858600	Front Panel Ass'y (EU)
2	07845800	Bonnet
3	46095200	LED, STEREO Ind.
4	07856500	Dial Pointer
5	46198900	LED, dial pointer
6	07851100	Push Knob (B) } FM/MW (LW)/SW1 (MW)
7	46182700	Push SW. } SW2 (SW)/FM MODE
8	07850200	Knob
9	46188900	100k Ω (B) x 2 VR } SW FINE TUNE
10	07850100	Knob, TUNING
11	46186300	Power Supply Cord (XX)
	46186400	Power Supply Cord (EU)
12	07852000	Slide Knob
13	46188800	150k Ω (B) x 2 } VOLUME
14	07851000	Push Knob (A) } SELECTOR/TAPE,
15	46182800	Push SW. } LOUDNESS
16	46095200	LED, TUNER/PHONO/TAPE Ind.
17	07852100	Knob, BASS/TREBLE/BALANCE
18	46189000	<100k Ω (C) x 2> x 2, 250k Ω (C) VR
19	07850900	Push Knob
20	07261300	Push SW. (XX) } POWER
	46085600	Push SW. (EU) }
21	07873010	Front Baffle Cover (B) Ass'y
22	07865800	FS-113 Fullrange Speaker Unit

Parts List <Rear View>

Parts No.	Stock No.	Description
1	46200000	Terminal, FM/SW 75 Ω , GND
2	46200100	4P Input Terminal, PHONO, AUX
3	46199400	Rod Antenna
4	46182300	AC Inlet (XX)
	46182400	AC Inlet (EU)
5	46200200	DIN Jack, speaker connector
6	07849700	Speaker Cord Reel (L)
7	07849900	Speaker Cord Reel (R)
8	07849600	Sub Speaker Cord Reel
9	46203100	2P DIN Speaker Cord
10	07853700	Leg

5-7. Top View <CP-R5>

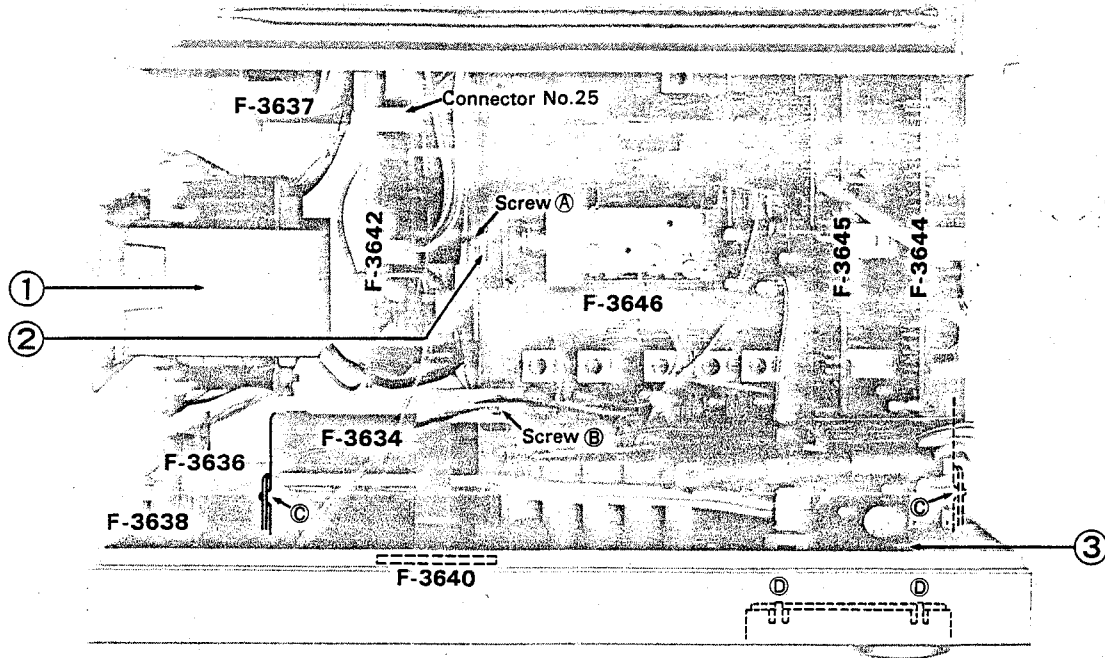

5-8. Bottom View <CP-R5>

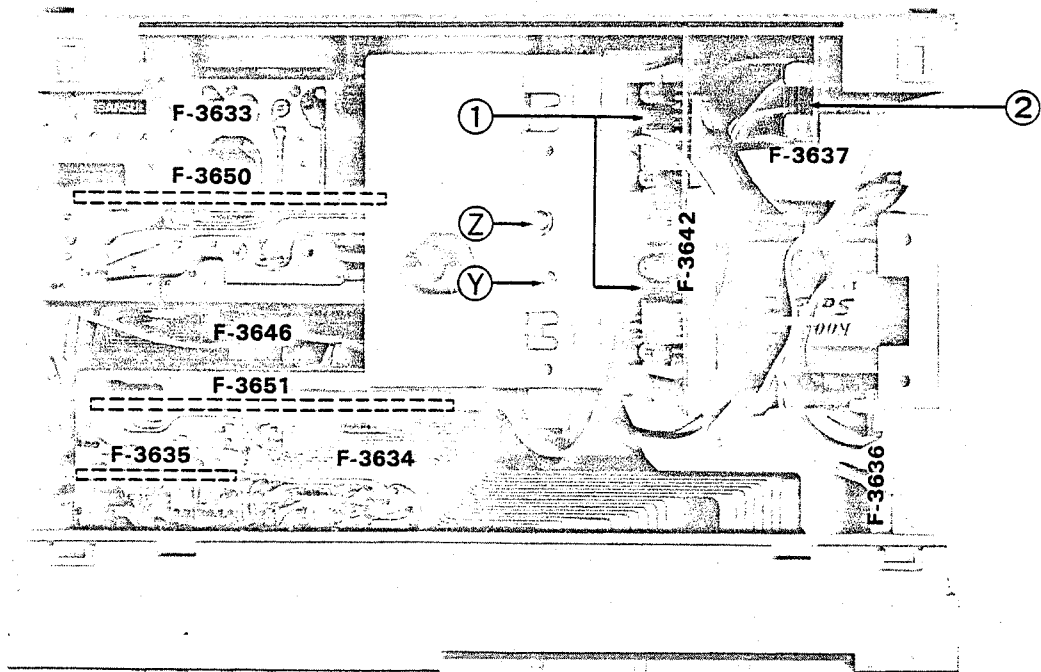

Parts List <Top View>

Parts No.	Stock No.	Description
1	15006601	Power Transformer (XX)
	15006605	Power Transformer (EU)
2	07779700	Pulley Ass'y
3	07860900	Tuning Unit

Parts List <Bottom View>

Parts No.	Stock No.	Description
1	46183600	μPC1230H Power IC
2	46201500	1A 250 V Fuse (120 V)(XX)
	46201200	500mA 250 V Fuse (220 V ~ 240 V)(XX)
	07184200	315mA 250 V Fuse (EU)

8. SCHEMATIC DIAGRAM 8-1. Audio Section <CP-R7>

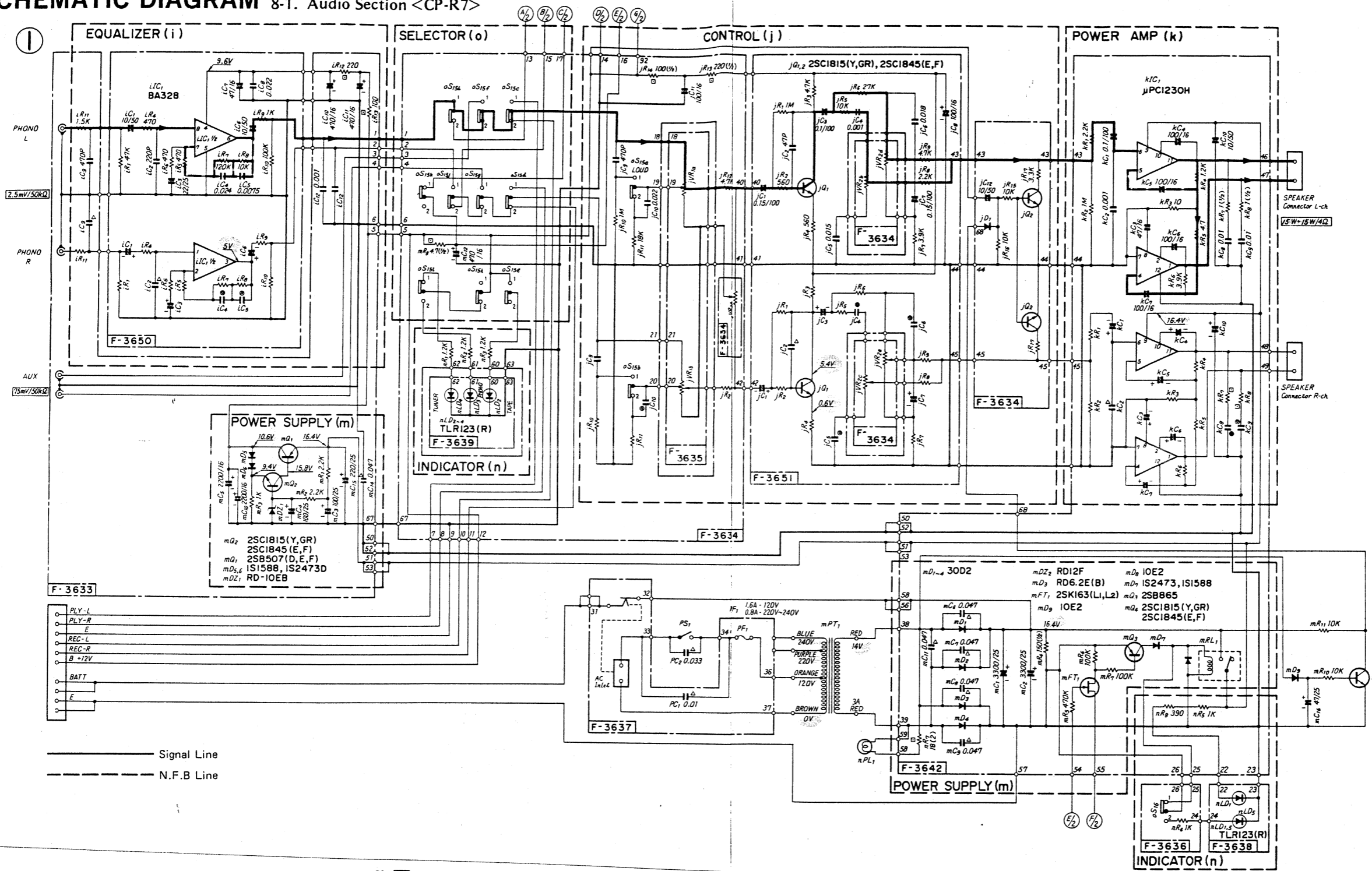

- 25A733
- 25A999
- 25A1015
- 25B865
- 25C945
- 25C1674
- 25C1675
- 25C1815
- 25C1845
- 25C2320
- 25C2878
- 25D438
- 2SK120
- 2SK163
- 2SB507
- TD6109P
- μPC1230H
- LA1231
- TC4001BP
- UPC1161C
- BA328
- DAN601
- DAN201
- DAP201
- 10E2
- 30D2
- 1N60
- 1S1588
- 1S2473D
- RD6.2E
- RD10E
- RD12F
- TC.9300F-001

— Signal Line
 - - - N.F.B Line

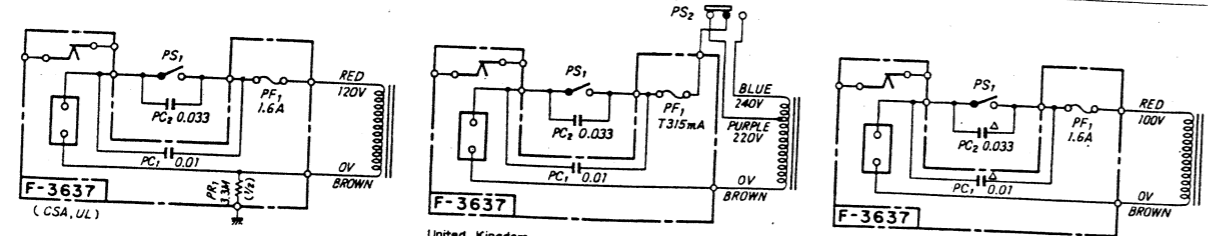

SYMBOL OF FUNCTION
 (d) FM
 (e) AM
 (i) EQUALIZER
 (j) CONTROL
 (k) POWER AMP
 (m) POWER SUPPLY
 (n) INDICATOR
 (o) SELECTOR
 (s) RF INDICATOR

SYMBOL
 ● Ceramic
 ● Mylar
 □ Non-Inflammable Resistors
 ● Polystyrene
RESISTORS
 Are in ohms, Watts, 5% Tolerance
 Unless Otherwise Noted: K:K, M:M, Ω:Ω
CAPACITORS
 Are in μF, Unless Otherwise Noted: P:pF
TOLERANCE
 J: ±5%, G: ±2%, F: ±1%
 Each D.C. Voltage shows the nominal value in volts at no input signal
 Electrolytic Capacitor: Capacitance (μF)/Volt (V)

*F-3634
 TUNER oS1a.1 1 ON
 2 OFF
 PHONO oS1a.1 1 ON
 2 OFF
 AUX oS1a.1 1 ON
 2 OFF
 TAPEPLAY oS1a.2 1 ON
 2 OFF
 LOUDNESS oS1a.3 1 ON
 2 OFF
 TIMER oS1a.4 1 ON
 2 OFF
 *F-3635
 VOLUME jVR1a.b
 *F-3634
 BALANCE jVR2a
 TREBLE jVR2b.c
 BASS jVR2d.e

8-2. Tuner Section <CP-R7 XX Model>

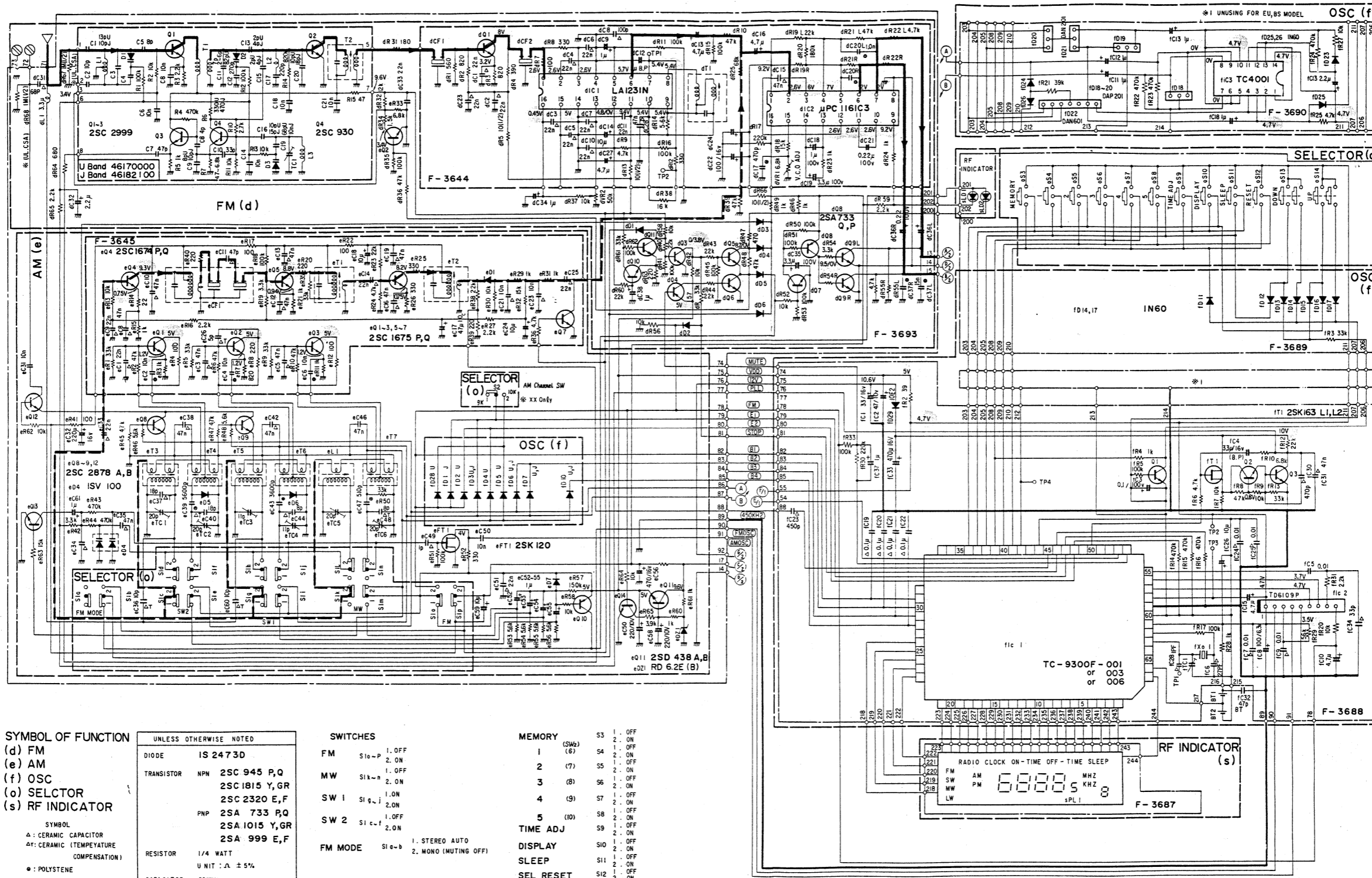

- 2SA733
- 2SA999
- 2SA1015
- 2SB865
- 2SC945
- 2SC1674
- 2SC1675
- 2SC1815
- 2SC1845
- 2SC2320
- 2SC2878
- 2SD438
- 2SK120
- 2SK163
- 2SB507
- TD6109P
- μPC1230H
- LA1231
- TC4001BP
- UPC1161C
- BA328
- DAN601
- DAN201
- DAP201
- 10E2
- 30D2
- 1N60
- 1S1588
- 1S2473D
- TC-9300F-001

SYMBOL OF FUNCTION
 (d) FM
 (e) AM
 (f) OSC
 (o) SELECTOR
 (s) RF INDICATOR

SYMBOL
 Δ: CERAMIC CAPACITOR
 ΔT: CERAMIC (TEMPERATURE COMPENSATION)
 ●: POLYSTYRENE
 ○: MYLAR

UNLESS OTHERWISE NOTED	
DIODE	IS 2473D
TRANSISTOR	NPN 2SC 945 P,Q 2SC 1815 Y,GR 2SC 2320 E,F PNP 2SA 733 P,Q 2SA 1015 Y,GR 2SA 999 E,F
RESISTOR	1/4 WATT UNIT : Δ ± 5%
CAPACITOR	50WV UNIT : F

SWITCHES	
FM	Sl o - P 1. OFF 2. ON
MW	Sl k - n 1. OFF 2. ON
SW 1	Sl e - i 1. ON 2. ON
SW 2	Sl c - f 1. OFF 2. ON
FM MODE	Sl e - b 1. STEREO AUTO 2. MONO (MUTING OFF)

MEMORY	
1 (S W 2)	53 1. OFF
2 (7)	54 2. ON
3 (8)	55 1. OFF
4 (9)	56 2. ON
5 (10)	57 1. OFF
	58 2. ON
	59 1. OFF
	60 2. ON
	61 1. OFF
	62 2. ON
	63 1. OFF
	64 2. ON
	65 1. OFF
	66 2. ON
	67 1. OFF
	68 2. ON
	69 1. OFF
	70 2. ON
	71 1. OFF
	72 2. ON
	73 1. OFF
	74 2. ON
	75 1. OFF
	76 2. ON
	77 1. OFF
	78 2. ON
	79 1. OFF
	80 2. ON
	81 1. OFF
	82 2. ON
	83 1. OFF
	84 2. ON
	85 1. OFF
	86 2. ON
	87 1. OFF
	88 2. ON
	89 1. OFF
	90 2. ON
	91 1. OFF
	92 2. ON
	93 1. OFF
	94 2. ON
	95 1. OFF
	96 2. ON
	97 1. OFF
	98 2. ON
	99 1. OFF
	100 2. ON

— FM Signal Line
 - - - AM Signal Line

1
 2
 3
 4
 5

8-5. Tuner Section <CP-R5>

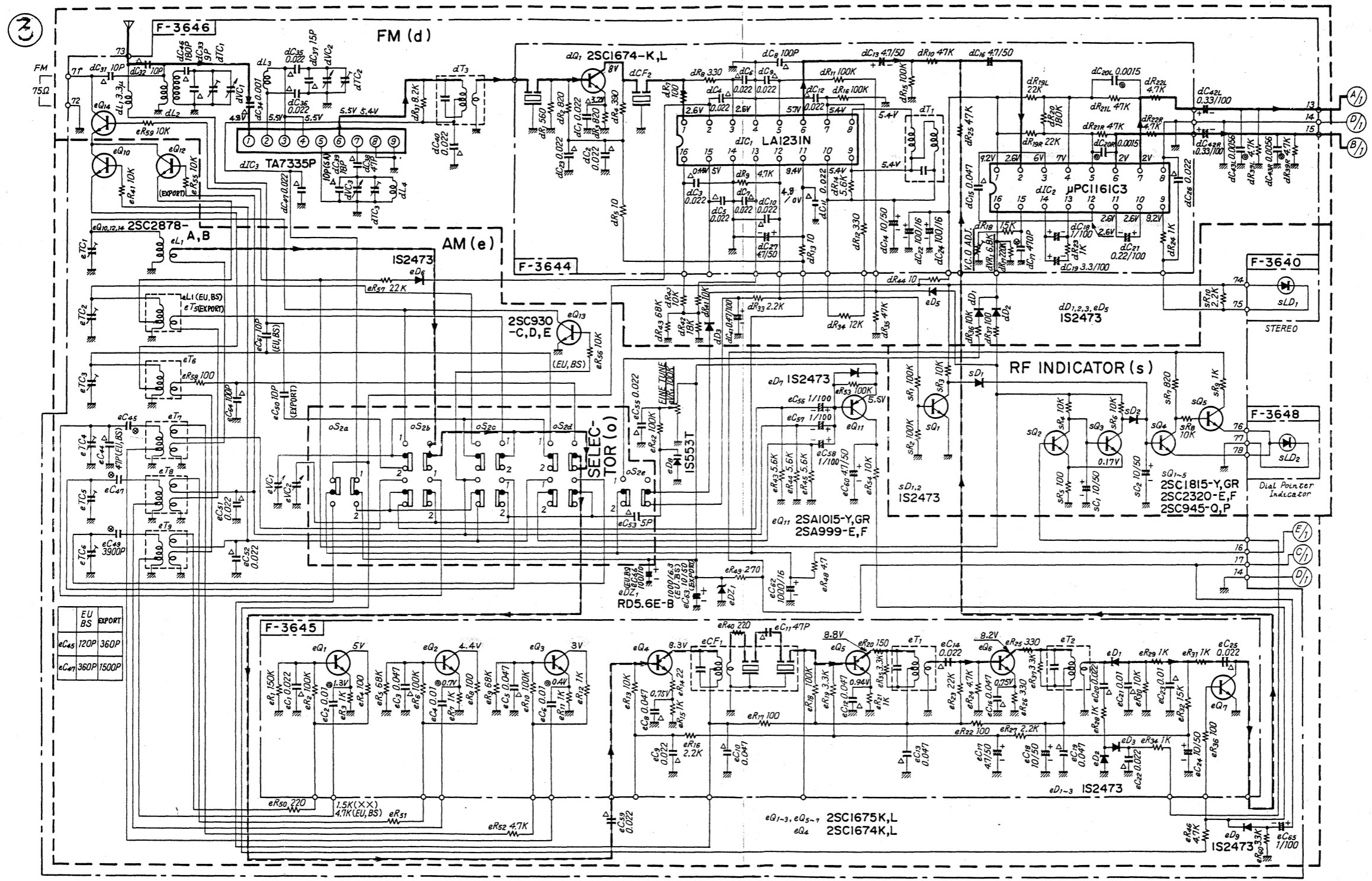

- 25B507
- 25A999
- 25A1015
- 25C930
- 25C945
- 25C1674
- 25C1675
- 25C1815
- 25C1845
- 25C2320
- 25C2878
- JPC1161C
- LA1231N
- TA7335P
- JPC1230H
- BA328
- 10E 2
- 30D 2
- 151588
- 152473D
- IS553T
- RD5.6E-B
- RD10E-B

- | | | | | | |
|----------|------|--------|--------------|------|-----------|
| FM | oS2a | 1. ON | SW2 (xx) | oS2d | 1. ON |
| | | 2. OFF | SW (EU) | | 2. OFF |
| MW (xx) | oS2b | 1. ON | FM MODE | oS2e | 1. STEREO |
| LW (EU) | | 2. OFF | | | 2. MONO |
| SW1 (xx) | oS2c | 1. ON | SW FINE TUNE | eVR1 | |
| MW (EU) | | 2. OFF | | | |

— FM Signal Line
 - - - AM Signal Line

1
 2
 3
 4
 5

3-2. Playback Adjustment

- Note: 1. Before this adjustment, clean REC/P.B. head surface.
 2. For this adjustment, use Sansui Test Tape, SCT-F10K, SCT-L400 and SCT-F1K.
 3. Set the Dolby NR switch to be OFF.
 4. REC Level Volume Max.
 5. Connections are shown in Fig. 3-3.

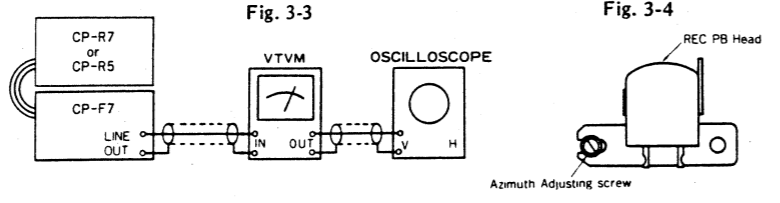

STEP	SUBJECT	MEASURE OUTPUT	SETTING	ADJUSTMENT	ADJUST FOR	REMARKS
1.	REC/P.B. Head Adj.	LINE OUT VTVM, Scope	Playback the TEST TAPE SCT-F10K	Adjust the azimuth adjusting screw in Fig. 3-4.	MAX. Output on both channels.	Refer to removal of Lid Ass'y on Page 35. After this adjustment, lock the screw with paint.
2.	Playback Level Adj.	Same as above	Set TAPE SELECTOR to NORMAL (LH) position. Playback the TEST TAPE SCT-L400	Adjust each vVR2 on L-CH and R-CH.	225mV ± 1dB	See Top View on Page 35.
3.	High Frequency Equalization Check	Same as above	Set TAPE SELECTOR to NORMAL (LH) position. Playback the TEST TAPE SCT-F1K.	—	—	Read output levels on both channels.
			Playback the TEST TAPE SCT-F10K.	—	—	Confirm that the output levels are within ± 3dB comparing with the above readings.

Note: On STEP 3, set the TAPE SELECTOR to HIGH (CrO₂) position during playback of SCT-F10K, and confirm the indication on VTVM drops approximately 3dB ~ 4dB.

3-3. Recording Adjustment

1) Bias Adjustment

- * Perform this adjustment when bias pot or REC/PB head is replaced.
 Note: 1. For this adjustment, use Sansui Test Tape, SCT-SA.
 2. Set the Dolby NR Switch to be OFF.
 3. Connections are shown in Fig. 3-5.

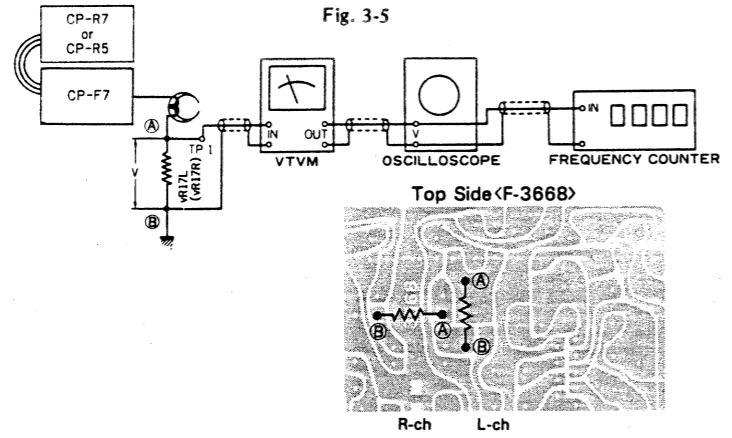

STEP	SUBJECT	MEASURE OUTPUT	SETTING	ADJUSTMENT	ADJUST FOR	REMARKS
1.	Recording Bias Adj.	Between (A) & (B) points of each vR17L, vR17R. VTVM, Scope, Frequency Counter	Load the TEST TAPE SCT-SA. Depress PAUSE, REC and PLAY buttons. Set TAPE SELECTOR to HIGH (CrO ₂) position.	Adjust vVR3L for L-CH and vVR3R for R-CH	5.0mV	vR17L and vR17R are shown in Fig. 3-6.
			Set TAPE SELECTOR to NORMAL (LH) position.	—	—	Confirm the indication on VTVM shows 3.5mV.
			Set TAPE SELECTOR to METAL position.	—	—	Confirm the indication on VTVM shows 9mV.
2.	Bias Frequency Check	Same as above	Load the TEST TAPE SCT-SA. Depress REC and PLAY button. Set TAPE SELECTOR to NORMAL (LH) position.	—	—	Confirm that the Frequency Counter shows 85kHz ± 10kHz.

2) REC Level & Frequency Response Adjustment

- Note: 1. Connections are shown in Fig. 3-7.
 2. Set the Dolby NR switch to be OFF.

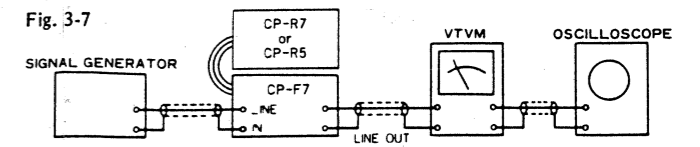

STEP	SUBJECT	INPUT SIGNAL	MEASURE OUTPUT	SETTING	ADJUSTMENT	REMARKS
1.	REC Level Adj.	Feed 1 kHz 100mV from S.G. into LINE IN.	LINE OUT VTVM Scope	Load the TEST TAPE SCT-SA. Set TAPE SELECTOR to HIGH (CrO ₂) position. 1. Depress PAUSE and REC button. 2. Adjust the Rec Level Volume for obtaining 180mV on VTVM. 3. Push on the PLAY button, then record the 1kHz signal. 4. Playback the 1kHz signal. 5. Confirm that the output levels on both channels are 180mV ± 2dB on VTVM.	1. If not, turn vVR1 (REC, L-CH) and vVR1 (REC, R-CH) until output level 180mV ± 2dB on both channels are obtained. 2. Repeat this REC Level adj. until the indication on VTVM will be 180mV ± 2dB.	vVR1 (REC, L-CH) and vVR1 (REC, R-CH) are shown in Top View on page 35.

3-4. Peak Level Indicator Adjustment

- Note: 1. Set the TAPE SELECTOR to be NORMAL (LH) position.
 2. Set the Dolby NR Switch to be OFF.
 3. Connections are shown in Fig. 3-8.

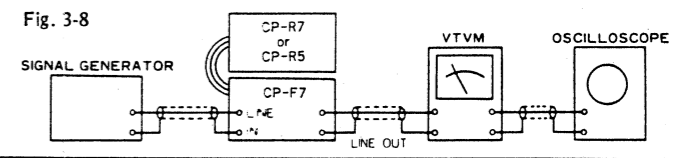

STEP	SUBJECT	INPUT SIGNAL	MEASURE OUTPUT	SETTING	ADJUSTMENT	REMARKS
1.	Peak Level Indicator Adjustment	Feed 1kHz, 100mV from S.G. into LINE IN	LINE OUT VTVM Scope	Load the TEST TAPE SCT-SA. 1. Depress PAUSE & REC button. 2. Adjust the REC Level Volume for obtaining 0dB point on Level Indicator. 3. Then confirm the output levels on both channels are 180mV ± 2dB on VTVM.	Adjust nVR1L for L-CH and nVR1R for R-CH.	After this adjustment, perform the SETTING 1 ~ 3 again.

◆ List of Sansui Test Tape

Name of TEST TAPE	Recorded Frequency	Description
SCT-F40	40 Hz	Playback Frequency Response Check
SCT-F1K	1 kHz	High Frequency Equalization Check
SCT-F10K	10 kHz	REC/PB Head Adjustment
SCT-L400N	400 Hz	Playback Level and Indicator Level Adjustment
SCT-S3K	3 kHz	Speed Check and Wow & Flutter Check
SCT-LH NORMAL (LH)		Recording Bias Adjustment
SCT-SA HIGH (CrO ₂)		REC/PB Level Adjustment
SCT-MA (METAL)		Frequency Response Check

◆ Tape Selector Position

NORMAL (LH)		HIGH (CrO ₂)	
FUJI	FL, FX I	FUJI	FX II
MAXELL	UL, UD, XLI, XLI-S	MAXELL	XL II, XL II-S
TDK	D, AD, OD	TDK	SA, SA-X
SCOTCH	TARTAN CRYSTAL MASTER 120	SCOTCH	MASTER 70
SONY	AHF, BHF, CHF Low-Noise	SONY	JHF
AGFA	SUPER SUPER COLOR SUPER FERRO DYNAMIC	AGFA	STEREO CHROM
BASF	LN Super LH I	BASF	SCR METAL
		MAXELL	MX
		TDK	MA-R, MA
		SCOTCH	Metafine
		SONY	METALLIC

5. EXPLODED VIEW & PARTS LIST

• Though every part included in mechanism ass'y is numbered in exploded view, part unlisted in the parts list are not supplied.

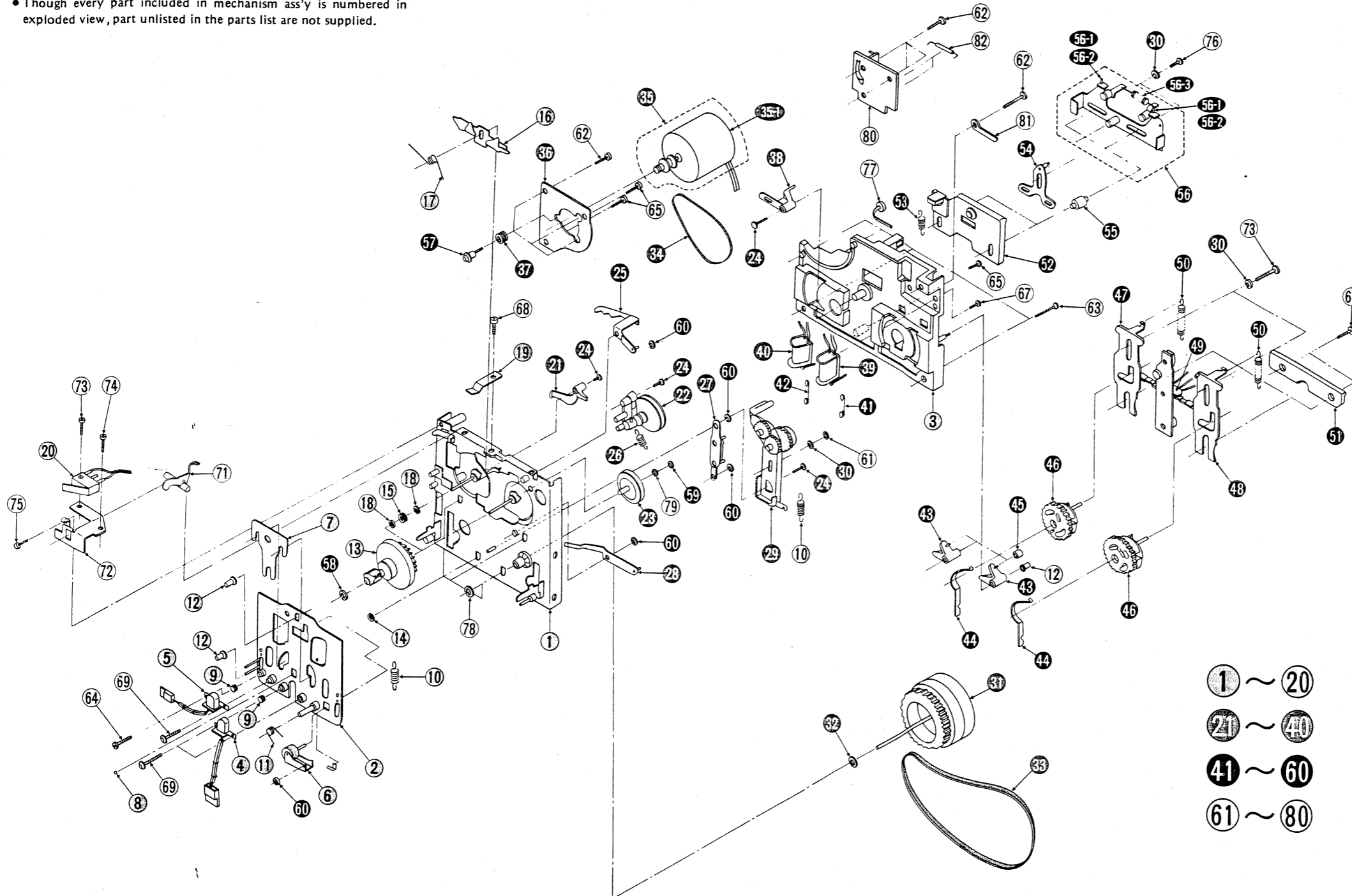

Parts No.	Stock No.	Description
3	46212600	Sub Chassis
4	46212700	REC/PB Head
5	09438200	Erase Head
6	46212800	Pinch Roller Ass'y
8	46212900	Steel Ball
13	46213300	Reel Ass'y, take-up, supply
14	07706900	Steel Ball
20	46213800	Micro SW, rec prevention
22	46214000	PLAY Idler Ass'y
23	46214100	Pulley
29	46214400	FF/REW Gear Ass'y
31	46214600	Flywheel Ass'y
33	46214700	Capstan Belt
34	46214800	Reel Belt
35	46214900	Motor Ass'y
37	07709200	Cushion Gum
39	46215100	Plunger Solenoid, REW
40	46215200	Plunger Solenoid, FF
43	46215500	Stopper, FF lever, REW lever
46	46215800	Cam Gear
49	46260500	Leaf SW
71	46217300	REC Prevention Nail
82	03117700	10E-2
•Spring		
9	07707200	Spring Azimuth
10	46213000	Spring, head base, ff/rew gear ass'y
11	46213100	Spring, pinch roller
15	46213400	Spring, back tension
19	46213700	Spring, cassette holder
26	46214200	Spring, play idler ass'y
41	46215300	Spring, rew plunger solenoid
42	46215400	Spring, ff plunger solenoid
44	46215600	Spring, cam gear start
45	46215700	Spring, stopper
50	46216200	Spring, ff lever, rew lever
53	46216400	Spring, play lever
56-2	46217800	Spring (A), ff/rew lever
56-3	46217900	Spring (B), ff/rew lever
•Screw, Washer		
12	46213200	Stopper (B), head base, rew stopper, head wire
18	07513000	Poly-washer D-2.0
24	07707000	Plastic-Tack, ff/rew lever, play idler ass'y ff/rew link lever, brake release lever
30	00466200	Plane-Washer
32	09442300	Poly-Washer D-2.5
56-1	46217700	Screw M2 x 8.5
57	46216700	Screw, motor
58	07708500	Poly-Washer, reel stopper
59	46216800	Poly-Washer, pulley stopper
60	00489000	E Type-Washer D-2.0
61	00488900	E Type-Washer D-1.5
62	00440400	Tapping Screw M2.6 x 6
63	46216900	Tapping Screw M2.6 x 16
64	46217000	Tapping Screw M2 x 8
65	00440500	Tapping Screw M2.6 x 10
67	00434200	Screw M2.6 x 4
69	46217200	Screw M2 x 10
73	46217400	Screw M2.3 x 10
74	08321200	Screw M3 x 5
75	00440400	Screw M2.6 x 5
76	00440500	Screw M2.6 x 8
78	09442100	Poly-Washer, oil stopper

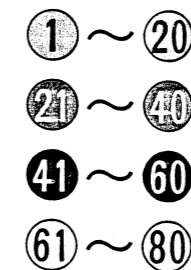

Abbreviations				
1. Pan Head Tapping Screw . . . PT Type	5. Pan Head SEMS B Screw . . . PSB Type	9. Flat Counter Sunk Wood Screw . . . FC Type	13. Binding Head SEMS B Screw . . . BSB Type	17. Toothed Lock Washer (External) . . . TLE Washer
2. Washer Head Tapping Screw . . . WT Type	6. Binding Head SEMS F Screw . . . BSF Type	10. Round Head Wood Screw . . . RH Type	14. Spring Washer . . . S Type	18. Wave Washer
3. Pan Head Screw . . . P Type	7. Binding Head Screw . . . B Type	11. Hex. Socket Setscrew . . . SC Type	15. Plain Washer . . . P Type	19. Hexagon Nut H Type Nut
4. Pan Head SEMS A Screw . . . PSA Type	8. Flat Counter Sunk Head Screw . . . F Type	12. Slot Type Setscrew . . . SS Type	16. Retaining Ring (E Washer) . . . E Type	

5. EXPLODED OTHER PARTS

• Thought exploded

Front View

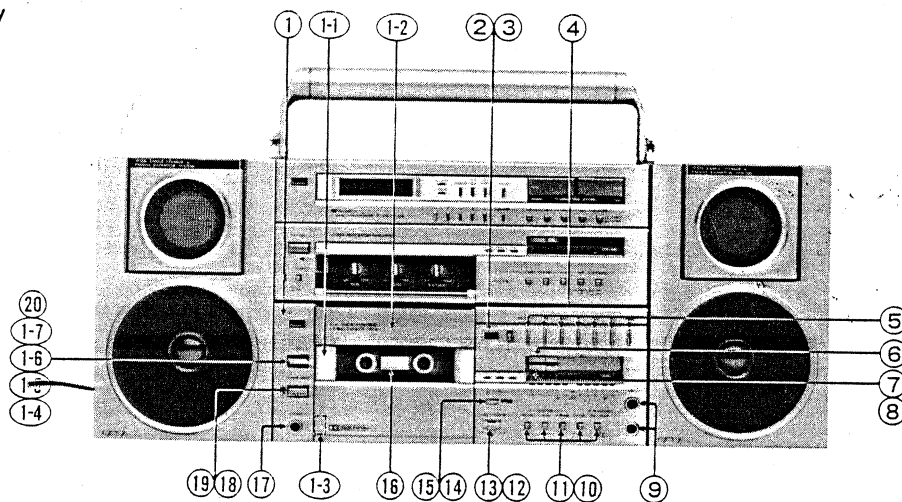

6-2. Rear View

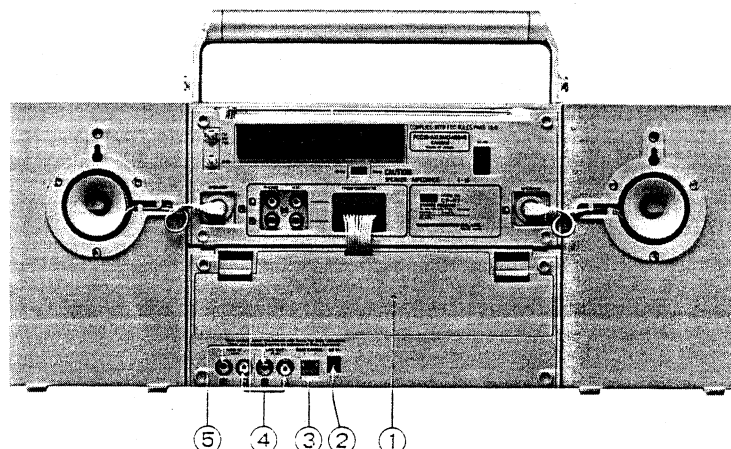

Parts List <Front View>

Parts No.	Stock No.	Description
1	07864000	Front Panel Ass'y
1-1	07858200	Cassette Well
1-2	07858300	Lid Ass'y
1-3	07864500	Spring, Lid
1-4	07862600	Knob, EJECT
1-5	07868100	Spring (A), EJECT knob
1-6	07864600	Shaft, EJECT
1-7	07868200	Spring (B), EJECT Shaft
2	46202600	TAPE COUNTER
3	07793400	Counter Belt
4	07846100	Bonnet
5	07854100	Knob, Control
6	07854300	Knob, LEVEL (L-ch)
7	07854200	Knob, LEVEL (R-ch)
8	46199500	Volume, REC LEVEL
9	46170600	Jack, MIC
10	07851000	Knob, SELECTOR, DOLBY, MIC MODE
11	46199900	Push SW, SELECTOR, DOLBY, MIC MODE
12	07853900	Knob, TIMER STAND-BY
13	46178400	Slide SW, TIMER
14	07854000	Knob, AMPS
15	07198200	Push Sw, AMPS
16	07859200	Mechanism Panel
17	46200400	Jack, phones
18	07850900	Knob, POWER/BATT.
19	07265300	Push SW, POWER/BATT.
20	46220200	Micro SW, EJECT

Parts List <Rear View>

Parts No.	Stock No.	Description
1	07846000	Battery Cover
2	46200310	Jack, DC
3	46177200	Slide SW, BEAT CANCEL
4	46199700	INPUT/OUTPUT Terminal (L-ch, white)
5	46199600	INPUT/OUTPUT Terminal (R-ch, red)

189

SERVICE MANUAL

PORTABLE COMPONENT SYSTEMS

SANSUI CP-7/CP-5

(Black Model)

Note: CP-7/CP-5 (black model) are additional models which exterior color are totally different from those CP-7/CP-5 (silver model).

This manual contains parts' items with bold-faced prints on black model and also common parts between black & silver CP-7/CP-5 in PACKING LIST, JOINT PARTS and OTHER PARTS.
On others, refer to CP-7/CP-5 Service Manual previously issued.

1. PACKING LIST

1-1. CP-7/CP-5 XX Model

Parts List		
Parts No.	Stock No.	Description
1	07870300	Vinyl Cover
2	07871700	Styrofoam Packing
3	47099300	Carton Case <CP-7>
	47099200	Carton Case <CP-5>

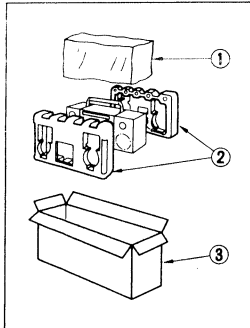

1-3. CP-S7/CP-S5 EU Model

Parts List		
Parts No.	Stock No.	Description
1	07870900	Vinyl Cover
2	07871900	Styrofoam Packing
3	47098800	Carton Case <CP-S7>
	47098400	Carton Case <CP-S5>

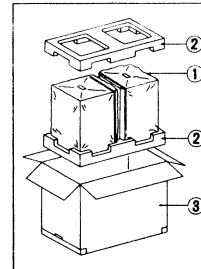

1-2. CP-R7/CP-R5/CP-F7 EU Model

Parts List		
Parts No.	Stock No.	Description
1	07870600	Vinyl Cover
2	07871800	Styrofoam Packing
3	47098600	Carton Case <CP-R7>
	47098200	Carton Case <CP-R5>
	47099000	Carton Case <CP-F7>

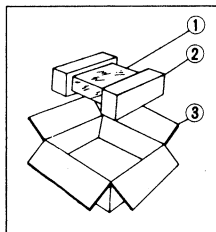

2. JOINT PARTS

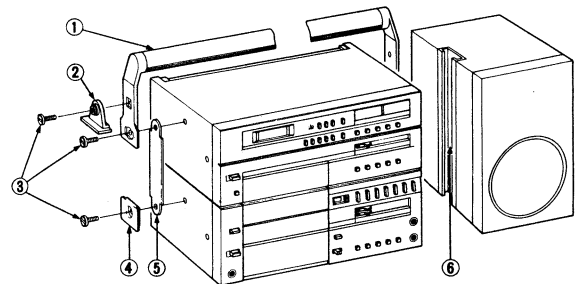

Parts List		
Parts No.	Stock No.	Description
1	47099900	Carrying Handle Ass'y
2	47095600	Speaker Stopper
3	47095100	Dress Screw
4	07855600	Cassette Washer
5	47095800	Handle Metal Plate Ass'y
6	47097800	Speaker Rail

3. OTHER PARTS

3-1. Front View <CP-R7/CP-S7>

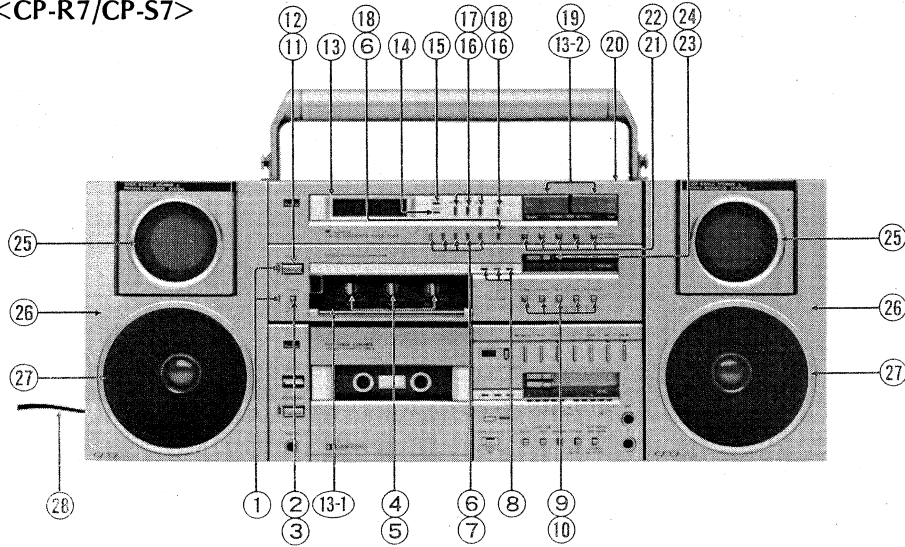

3-2. Rear View <CP-R7/CP-S7>

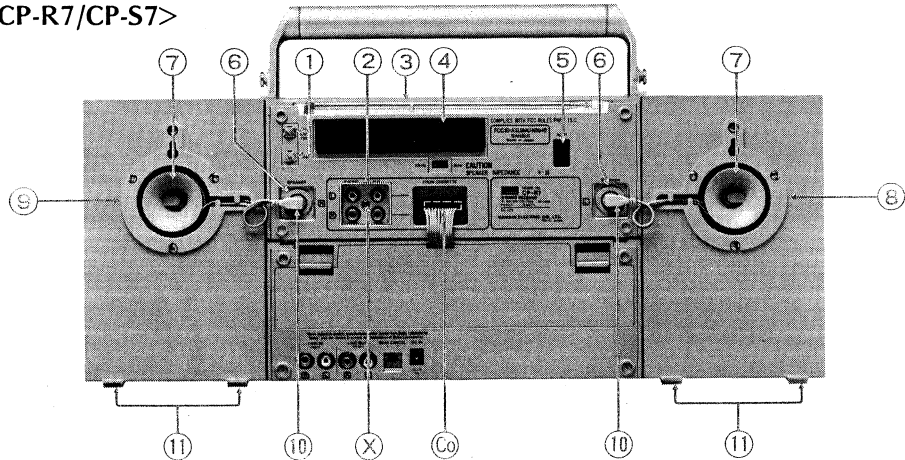

Parts List <Front View>

Parts No.	Stock No.	Description
1	46095200	LED, TIMER/POWER Indicator
2	46182600	Push SW., TIMER
3	07851000	Knob, TIMER SW.
4	46189100	BALANCE/TONE VR, 100k Ω x 2, 250k Ω
5	47103200	Knob, BALANCE/TONE VR
6	46184600	Push SW., 1 ~ 5 (MEMORY)/MEMORY
7	47095300	Knob, 1 ~ 5 (MEMORY)
8	46095200	LED, PHONE/TAPE/TUNER
9	46182800	Push SW., SELECTOR/TAPE/LOUDNESS
10	07851000	Knob, SELECTOR/TAPE LOUDNESS SW.
11	07261300	Push SW., POWER
12	47096100	Knob, POWER SW.
13	47102200	Front Panel Ass'y (XX)
	47102300	Front Panel Ass'y (EU)
13-1	07848700	Tone Volume Cover
13-2	07850800	UP, DOWN SW. Knob
14	46095200	LED, STEREO Indicator
15	07250900	LED, LOCKED Indicator
16	46184600	Push SW., DISPLAY/TIME ADJ./SEC RESET/SLEEP
17	47119700	Knob, DISPLAY/TIME ADJ./SEC RESET SW.
18	07850700	Knob, SLEEP SW.
19	07224100	Push SW., UP/DOWN
20	47105810	Bonnet

Parts No.	Stock No.	Description
21	46182700	Push SW., FM/MW/SW1/SW2 (LW)/FM MODE SW
22	07851100	Knob, FM/MW/SW1/SW2 (LW)/FM MODE SW.
23	46188800	Slide VR 150k Ω x 2, master VR
24	47100000	Knob, master VR
25	46203800	Passive Radiator, P-111
26	47117200	Front Baffle Cover (E) Ass'y
27	46203700	FS-114, Fullrange Speaker
28	46186300	Power Supply Cord (XX)
	46186400	Power Supply Cord (EU)

Parts List <Rear View>

Parts No.	Stock No.	Description
1	46200000	Terminal, FM 75 Ω /GND
2	46200100	4P Input Terminal
3	46199400	Rod Antenna
4	47095200	Battery Case Cover
5	46182300	AC Inlet (XX)
	46182400	AC Inlet (EU)
6	46528100	DIN Jack, SPEAKER Connector
7	47097400	Sub Speaker Cord Reel
8	47101100	Speaker Cord Reel (L-ch)
9	47101000	Speaker Cord Reel (R-ch)
10	46203100	2P DIN Speaker Cord
11	47097500	Leg

3-3. Front View <CP-R5/CP-S5>

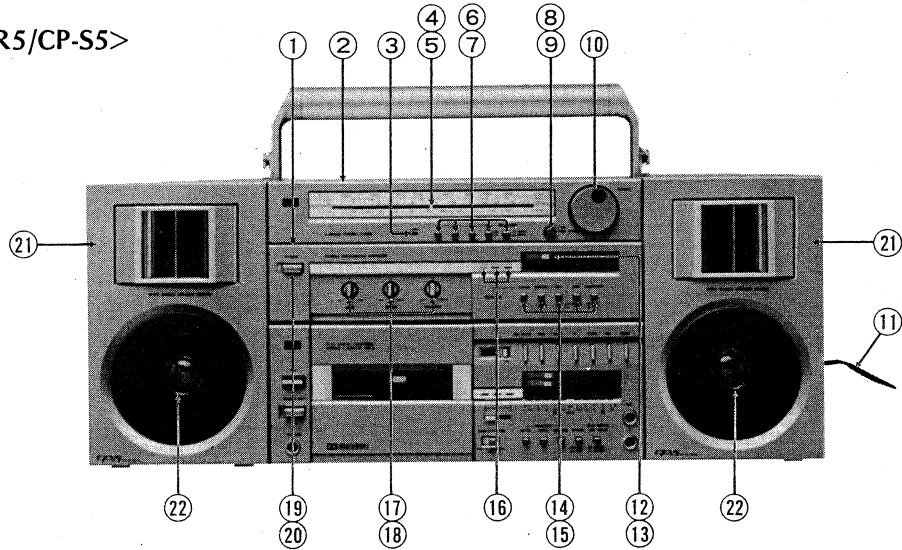

3-4. Rear View <CP-R5/CP-S5>

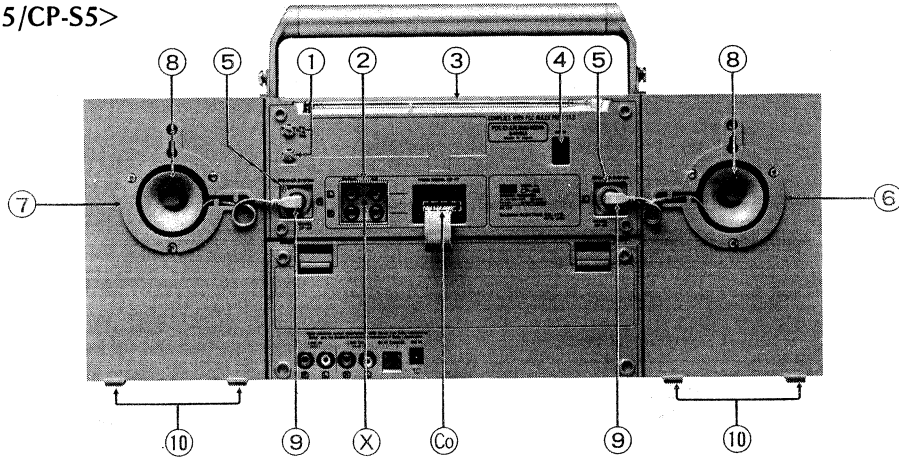

Parts List <Front View>

Parts No.	Stock No.	Description
1	47100300	Front Panel Ass'y (XX)
	47100400	Front Panel Ass'y (EU)
2	47105810	Bonnet
3	46095200	LED, STEREO Ind.
4	07856500	Dial Pointer
5	46198900	LED, dial pointer
6	07851100	Push Knob (B) } FM/MW (LW)/SW1 (MW)
7	46182700	Push SW. } SW2 (SW)/FM MODE
8	47103400	Knob
9	46188900	100kΩ (B) x 2 VR } SW FINE TUNE
10	47103300	Knob, TUNING
11	46186300	Power Supply Cord (XX)
	46186400	Power Supply Cord (EU)
12	47100000	Slider Knob
13	46188800	150kΩ (B) x2 Slide VR } VOLUME
14	07851000	Push Knob (A) } SELECTOR/TAPE
15	46182800	Push SW. } LOUDNESS
16	46095200	LED, TUNER/PHONO/TAPE Ind.
17	47103200	Knob, BASS/TREBLE/BALANCE
18	46189000	<100kΩ (C) x 2> x 2, 250kΩ (C) VR
19	47096100	Push Knob
20	07261300	Push SW. (XX) } POWER
	46085600	Push SW. (EU) }
21	47097300	Front Baffle Cover (D) Ass'y
22	07865800	FS-113 Fullrange Speaker Unit

Parts List <Rear View>

Parts No.	Stock No.	Description
1	46200000	Terminal, FM/SW 75Ω, GND
2	46200100	4P Input Terminal, PHONO, AUX
3	46199400	Rod Antenna
4	46182300	AC Inlet (XX)
	46182400	AC Inlet (EU)
5	46528100	DIN Jack, speaker connector
6	47101100	Speaker Cord Reel (L)
7	47101000	Speaker Cord Reel (R)
8	47097400	Sub Speaker Cord Reel
9	46203100	2P DIN Speaker Cord
10	47097500	Leg

3-5. Front View <CP-F7>

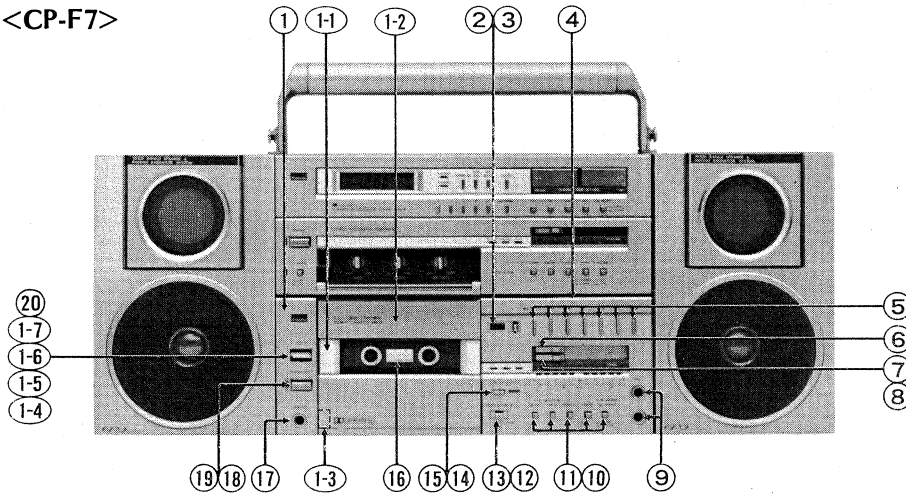

3-6. Rear View <CP-F7>

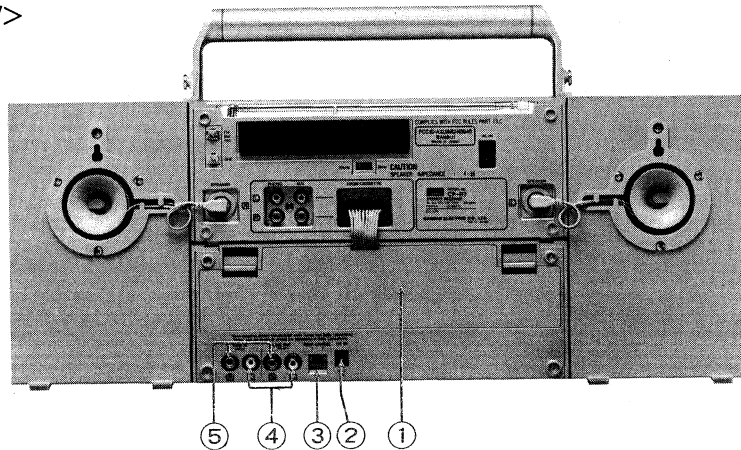

Parts List <Front View>

Parts No.	Stock No.	Description
1	47104200	Front Panel Ass'y
1-1	47100700	Cassette Holder
1-2	47100800	Lid Ass'y
1-3	07864500	Spring, Lid
1-4	47118400	Knob, EJECT
1-5	07868100	Spring (A), EJECT knob
1-6	07864600	Shaft, EJECT
1-7	07868200	Spring, EJECT Shaft
2	46367900	TAPE COUNTER
3	46368010	Counter Belt
4	47105900	Bonnet
5	47097100	Knob, Control
6	47097200	Knob, REC
7	47101400	Knob, LEVEL (L-ch)
7	47101300	Knob, LEVEL (R-ch)
8	46199500	Volume, REC LEVEL
9	46170600	Jack, MIC
10	07851000	Knob, SELECTOR, DOLBY, MIC MODE
11	46199900	Push SW. SELECTOR, DOLBY, MIC MODE
12	47096900	Knob, TIMER STAND-BY

Parts No.	Stock No.	Description
13	46178400	Slide, SW., TIMER
14	47097000	Knob, AMPS
15	07198200	Push SW., AMPS
16	07942500	Mechanism Panel
17	46313300	Jack, phones
18	47096100	Knob, POWER/BATT.
19	07265300	Push SW., POWER/BATT.
20	46220200	Micro SW., EJECT

Parts List <Rear View>

Parts No.	Stock No.	Description
1	07846000	Battery Cover
2	46200310	Jack, DC
3	46177200	Slide SW., BEAT CANCEL
4	46199700	INPUT/OUTPUT Terminal (L-ch, white)
5	46199600	INPUT/OUTPUT Terminal (R-ch, red)

	SANSUI ELECTRIC CO., LTD.:	14-1, Izumi 2-chome, Suginami-ku, Tokyo 168 Japan
	SANSUI ELECTRONICS CORPORATION:	PHONE: (03) 324-8891/TELEX: 232-2076 (International Division)
	SANSUI ELECTRONICS (U.K.) LTD.:	1250 Valley Brook Ave. Lyndhurst, N.J. 07071 U.S.A.
	SANSUI ELECTRONICS G.M.B.H.:	333 West Alondra Blvd. Gardena, California 90247 U.S.A.
		3036 Koapaka St. Honolulu, Hawaii 96819 U.S.A.
		Unit 10A, Lyon Industrial Estate, Rockware Avenue, Greenford, Middx UB6, OAA, England
		Paul Ehrlich Strasse 8, 6074 Rödermark 2, West Germany